

California Community Colleges

# Space Inventory Handbook

*June 2007*



College Finance & Facilities Planning Division  
Facilities Planning Unit  
System Office, California Community Colleges

# TABLE OF CONTENTS

Reference Sections .....	2
Preface.....	3
Introduction.....	4
Space Inventory Overview .....	5
Legal Authorization .....	5
Who Supplies the Data for Space Inventory Update? .....	5
Data Validity and Reliability.....	5
The Inventory Process.....	6
General Information .....	7
Procedural Preview .....	7
Input Process.....	8
Submittal Procedures .....	11
Definition of Facility Inventory Terms.....	12
What Spaces are to be Inventoried?.....	12
Building Input Data.....	12
ID Number .....	12
College Name .....	12
Building Number .....	12
Location Code.....	12
Building Name.....	12
Outside Gross Square Feet.....	14
Room Input Data.....	15
Room Prefix.....	15
Room Number .....	15
Room Suffix.....	15
Department Number .....	15
Program Number .....	15
TOP/CSS Code.....	15
Room Use .....	15
Assigned Square Feet.....	15
Assigned Stations.....	15
District Inventory Checklist .....	16

## Reference Sections

<b>Reference Section A</b> - Code Numbers for California Community Colleges .....	17
<b>Reference Section B</b> - Classification of Building Areas .....	23
Definitions of Building Areas .....	25
Diagram of Building Areas .....	29
<b>Reference Section C</b> - Program Number Structure .....	43
Purpose of Program Structure .....	45
Organization of Program Number Structure .....	45
Program Numbers .....	46
<b>Reference Section C.1.</b> - Classification Categories (CSS)	
Service and Support .....	48
Instructions for Use .....	49
Summary List .....	50
Service Categories .....	53
<b>Reference Section D</b> - Room Use Categories .....	61
Summary .....	62
Room Use Categories .....	63
<b>Reference Section E</b> - Suggested Standard Patterns for Room Numbering .....	85
Development of a Pattern .....	87
Application of Pattern .....	88
Special Considerations .....	89

## PREFACE

The annual *California Community College Space Inventory* provides a centralized legal record of assignable square feet for community college purposes. The management of such an enterprise is a legitimate concern for the citizens of the state, local and state governing boards and Legislature.

The *Space Inventory* provides basic information used in calculating state funding for capital outlay projects and maintenance and operations. In addition, the *Space Inventory* provides verification of current and anticipated facilities gross square footage in the district. The annual report provides a statistical legal record of gross and assignable square feet used for evaluating, planning and administering all community college facilities under district ownership and/or control. Furthermore, an accurate *Space Inventory* report provides an indispensable database for considering planning problems. The database is made available to other state agencies associated with the funding of capital outlay needs under legislative jurisdiction.

This 2007 version of the *California Community College Space Inventory Handbook* is designed to be a permanent reference guide. Periodically, the FACILITIES PLANNING UNIT of the System Office will revise pages/sections incorporating policy changes to be used in completing the *Space Inventory* report. The revised version of the handbook will be posted in the *Reference Materials* section of the FACILITIES PLANNING UNIT website at <http://www.cccco.edu/divisions/cffp/facilities/refs/refs.htm> . There have been numerous changes in procedures, codes and reporting to ensure consistency with other Community College publications and policies. Please check carefully as to the appropriate designation for your college/district.

The actual *Space Inventory* information is contained in a database module found in the FUSION (Facility Utilization Space Inventory Option Net) website at <http://fusion.deltacollege.edu/fusionforum/forumhome.htm>. For access to the information in the FUSION database contact your district's FUSION Administrator or the FUSION Help Desk at [FUSIONhelp@foundationccc.org](mailto:FUSIONhelp@foundationccc.org) for assistance. The FUSION Forum website link identified above also contains additional information about other FUSION modules used in the development of the facility planning and management.

If you have any questions regarding this manual or inventory policies, please call your facilities specialist or the FACILITIES PLANNING UNIT at (916) 445-8283. Or you may write to:

Fred Harris, Assistant Vice Chancellor  
COLLEGE FINANCE & FACILITIES PLANNING DIVISION  
California Community Colleges  
1102 Q Street  
Sacramento, CA 95814

# INTRODUCTION

## Purpose

The purpose of this *Space Inventory Handbook* is twofold:

1. To present procedures for the planning, maintenance and operation of the California Community College space.
2. To serve as an information facility data manual for users in respective colleges, districts and State agencies.

## Why a Space Inventory?

*California Education Code* Section 81821(e) requires "an annual inventory of all facilities of the district."

The *California Community Colleges Space Inventory* provides planning and management data about existing physical facilities. The building and room data are for planning, scheduling, assigning and accounting for the various types of spaces in facilities available for serving the purposes of the California Community Colleges.

The uses and the applications of the space inventory are:

1. Serves as an integral part of the annual *Five-Year Construction Plan* (EC Section 81821).
2. Assignment and control of college campus space.
3. Analysis of space utilization.
4. Projecting future facility needs.
5. Project planning for capital outlay construction.
6. Development and maintenance of facility allocation and utilization standards and guidelines.
7. Development of capital outlay and maintenance budgets.
8. Preparing equipment budgets.
9. Measuring operating budget workloads.
10. Helping in program budgeting.
11. Assisting in the management of insurance.
12. Preparing reports, audits, contracts and accounting for regional, state and federal activities.

As the California Community Colleges adapt to demographic and economic changes, informational needs will increase, and most assuredly, there will be continuing demands for accurate space inventory data.

# SPACE INVENTORY OVERVIEW

## Legal Authorization

The *California Community Colleges Space Inventory* is mandatory pursuant to *Education Code* Sections 71028, 81800, and 81821(e); Section 71028 states, "The Board of Governors shall **review and approve academic master plans and master plans for facilities** for each community college district." A more specific requirement is given in Section 81821(e) which requires, "An annual inventory of all facilities of the district using standard definitions, forms and instructions adopted by the Board of Governors."

The space inventory as required by statute provides the essential database for examining utilization of facilities and, as a consequence, the planning for, allocation of, and addition to the statewide *Five-Year Construction Plan* prepared each year.

The space inventory format consists of a facilities inventory list, reports and summaries. The inventory list provides a room summary for each building plus identifying quantitative data. The reports are organized with various formats that provide detailed information on facility identification, room and standard classification data. In addition, the reports provide detail on the number of rooms, assignable square feet, number of stations and other facilities data. The summaries give college, district and statewide totals from report data.

## Who Supplies the Data for Space Inventory Update

Generally, an individual in each college and/or district is assigned to prepare the input data. The person responsible for space management and reporting should have a basic knowledge of the college campus physical plant. He or she should be given assistance, and if necessary, technical help when evaluating existing or proposed structures. In multi-campus districts the data will be submitted from the district office, but in all cases individual approved college, campus and center identities will be retained.

In most multi-campus districts there is a separate administrative office serving several colleges. Where such a situation exists, a separate input report is required for the administration office in addition to the data for each college. Likewise, a district "center" either owned or fully controlled by lease is assigned an identification number and accounted for in the same manner as a "college".

## Data Validity and Reliability

The information reported for each community college provides an important portion of the database for all capital outlay programs. Therefore, accuracy, consistency and reasonableness are of prime importance. If the basic data are correct, only changes made in each subsequent year are necessary to maintain a constant inventory of all space within college facilities.

Significant variations have been found to exist in space inventory data when audit checks have been made. Variations have occurred with sufficient frequency to recommend caution and care. When and where inaccurate data are found, the correction process becomes tedious and involved. **Doing it properly the first time** is the most profitable use of time and effort.

## The Inventory Process

The inventory process consists of **Input**, **Evaluation** and **Printout**.

*Input.* The district or college completes new data via the *Space Inventory FUSION* database. The input data are for 1) **college**, 2) **building** and 3) **room** of all spaces anticipated to be used by the college or district as of December 31 of the current year.

*Evaluation.* Once the *Space Inventory FUSION* database has been updated and submitted electronically via the “submit” button in FUSION, the only remaining submittal task is to printout and sign the *Room Use Summary - Report 17* site certification pages for each site in the district. These pages are the ONLY hard copy submittals required to be sent to the System Office by October 1. It is no longer necessary to send complete hard copies of the *Room Use Summary - Report 17* forms.

Upon the System Office receipt of the data file and *Room Use Summary - Report 17* signed site certification pages (due October 1), all data are checked and compared with the prior year inventory. If clarifications or corrections are necessary, the System Office will contact the district to resolve the matter.

*Certified Version.* By December 1 each district will receive a signed, certified *Room Use Summary - Report 17* from the System Office. The certified *Space Inventory FUSION* database is to be used throughout the year in review of facilities planning and use.

# GENERAL INFORMATION

## Inventory Data Access

The FUSION database is a password protected database. If non-district personnel wish to see a copy of the district's *Space Inventory Report* they should contact the district administration for a copy.

The main focus of the information provided in this manual is intended for district representatives charged with entering data into the *Space Inventory Report* via the FUSION database.

## Procedural Preview

The *Space Inventory Report* is to include all current and anticipated facilities space as of December 31 of the current year. The annual report (**due October 1**) is prepared by: 1) updating an existing college's inventory and 2) reporting inventories for new colleges/centers.

An existing college inventory requires an annual update of facility data. This includes correcting all known errors in the prior year space inventory. All building and room changes are noted in the *Space Inventory* FUSION database. The *Space Inventory* FUSION database contains a reconciliation report which will track the changes made in the current year in comparison to past submittals years. FUSION will have a unclassified space report that will show all space identified during the most recent Facilities Condition Assessment update done by the CCC Foundation assessors. Districts should clear this report prior to submitting their *Space Inventory Report*.

Adding new college or entity inventories are more complicated. This requires measuring all rooms and buildings and naming the college or entity. A college or entity code number must be obtained from the System Office, FACILITIES PLANNING UNIT.

Updated data are prepared and evaluated for computer input. The final result is a district comprehensive facilities report (*Room Use Summary - Report 17*). The printout provides an inventory listing and several summary reports with breakdowns by room, building and colleges for the use of both the district and the state. The *Room Use Summary - Report 17* is submitted to the state electronically via the *Space Inventory* FUSION database.

Space inventory data are needed for the preparation of *Five-Year Construction Plans*, *Final Project Proposals (FPPs)* and other administrative purposes. The data will be used as the basis for justifying construction projects submitted to the System Office.

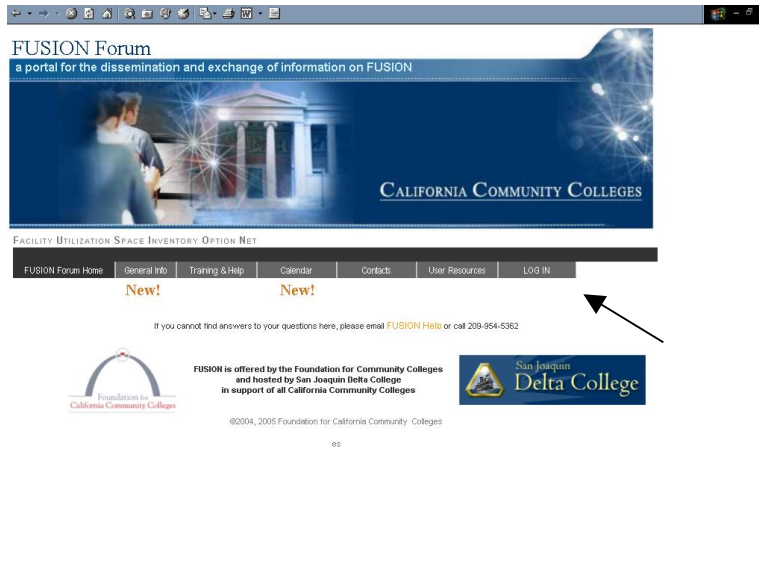
The data are also used by other state agencies including the California State Department of Finance, the Legislative Analyst and the California Postsecondary Education Commission. In addition, data are used for federal reporting.



## Input Process

The *Space Inventory* data is entered into the FUSION database for submittal to the System Office. Access to the FUSION database is via the FUSION Forum website, <http://fusion.deltacollege.edu/fusionforum/forumhome.htm>, (see screen shots below). If you do not have a username and password established for FUSION contact your district FUSION administrator for assignment of one.

Select “Log In” link



Select “FUSION Live” link

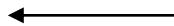
## FUSIONForum

### FACILITY UTILIZATION SPACE INVENTORY OPTION NET



Select your login

- **FUSION Live**
- **FUSION Training**
- **Citrix/ COMET**



Log into FUSION using your username and password



The FUSION database has a self-help tab labeled Emanual in the upper right hand corner that contains instructions for better understanding the *Space Inventory* module. If you wish to receive further training on entry of data into the *Space Inventory* module or other FUSION database modules, please contact the FUSION help desk at [fusionhelp@foundationccc.org](mailto:fusionhelp@foundationccc.org).

For those districts desiring new room number patterns, or new districts numbering facilities for the first time, please see **Reference Section E**, *Suggested Standard Patterns for Room Numbering*.

**The acceptance of district data by the System Office is often delayed for the following reasons:**

*Omissions* - the absence of needed data is obviously a serious omission. It is necessary that information submitted be complete when making any "add", "delete" or "change".

*Mistakes* - It is suggested that one or more persons check the input data. Preventing the probability for error when dealing with numerical information requires constant vigilance throughout the process.

The two most commonly made errors are **wrong classification numbers** and **incorrect room or building numbers**.

*Duplications* - Frequently attempts are made to enter data that are already recorded on the existing inventory.

In the event of computer access related problems please contact the FUSION help desk at [fusionhelp@foundationccc.org](mailto:fusionhelp@foundationccc.org), If you have space use or type questions please contact your facilities specialist or the System Office FACILITIES PLANNING UNIT at (916) 445-8283.

## Submittal Procedures

### District Submittal Process

Each district must annually prepare a *Space Inventory Report* by **October 1** that includes all current and anticipated available space **through December 31 of the current calendar year**. Please submit the *Room Use Summary - Report 17* site certification pages for each site in the district to:

**California Community Colleges  
System Office  
FACILITIES PLANNING UNIT  
1102 Q Street  
Sacramento, CA 95814**

1. Update the *Space Inventory* FUSION database and submit electronically via the “submit” button in the *Space Inventory* FUSION database.
2. Print out and sign the *Room Use Summary - Report 17* site certification pages for each site in the district. Send the wet copy pages to the address shown above.

The System Office FACILITIES PLANNING UNIT will review and approve the *Room Use Summary - Report 17* data and certify its accuracy. A **signed, certified report** will be returned to each district by the System Office **December 1**. This certified form is to be incorporated in the district's *Five-Year Construction Plan* and any *Final Project Proposal* as submitted by the district **due the following July 1**.

## DEFINITION OF FACILITY INVENTORY TERMS

The Classification of Building Areas as given in **Reference Section B** should be studied in detail, especially if personnel are new or if **new** college space is being established.

### What Spaces are to be Inventoried?

Inventory only those spaces of facilities (buildings) **owned, leased** and/or **controlled** by the college and/or district. A complete list of sites can be found in **Reference Section A**. **Controlled** means access from 8:00 a.m. to 10:00 p.m. during the regular five-day week. There may also be very special instances where college or district buildings may be owned but not controlled. In such circumstances the building should be cited for reference in the *Five-Year Construction Plan*, and **included** in the *Space Inventory*.

### Building Input Data

**District Name:** Select District name from the *Space Inventory* tree on the left

**College/Center Name:** Select College name from the tree on the left. Select the “add” feature in the right side window.

**Building Number:** (Building #) the module will enter the next available building number for you, but it can be overwritten provided that the number is not currently used.

**Note:** **Deleting a building will automatically delete all rooms inventoried in that building.** Refer to **Reference Section F** for instructions on the best method to make room number changes.

**Building Name:** Twenty-four characters are provided for the building name. Use letters or numbers; hyphens are permitted.

**Abbreviation:** Six characters are provided for the building abbreviation. Use letters or numbers; hyphens are permitted.

**Plan Type:** A choice of two options is given in the pulldown menu. Select one:  
Permanent  
Temporary

**Note:** Follow requirements of *California Code of Regulations: Title 5, Section 57001(d)*:

"*Temporary building* means an on-campus building of limited worth which, according to the capital construction master plan, is anticipated to be demolished or replaced within five years. All other buildings are to be considered permanent."

**Location Code:** A choice of four options is given in the pull down menu. Select one:  
District Headquarters  
College/Campus  
Center  
Off-Campus Location

**Ownership Code:**

Choose one of the following from the pull down menu:

1. Owned in fee simple.
2. Title vested in the district and being paid for on an amortization schedule (regardless of whether the building is shared with another institution or organization).
3. Title vested in a holding company or building corporation to which payments are being made by the district; title will ultimately pass to the district. (Includes lease-purchase arrangements or facilities built since 1987 which may have been funded through state revenue bonds.)
4. Not owned by the district, but leased or rented to the district at a typical local rate.
5. Not owned by the district, but made available to the district either at no cost or a nominal rate.
6. Not owned by the district, but shared with an educational organization that is not a postsecondary institution.
7. Not owned by the district, but shared with another postsecondary educational institution.
8. Other (e.g., not owned by the district, but shared with a non-educational institution).
9. District-owned facilities leased or rented to other parties (not in use by the college/district).

**Condition Code<sup>1</sup>:**

Choose one of the following from the pull down menu:

1. *Satisfactory*  
  
Suitable for continued use with normal maintenance.
2. *Remodeling - A*  
  
Requires restoration to present Uniform Building Code standards without major room use changes, alterations or modernization. The approximate cost of "Remodeling - A" is not greater than twenty-five (25) percent of the estimated replacement cost of the building.
3. *Remodeling - B*  
  
Requires major updating and/or modernization of the building. The approximate cost of "Remodeling - B" is greater than twenty-five (25) percent, but not greater than fifty (50) percent of the estimated replacement cost of the building.
4. *Remodeling - C*  
  
Requires major remodeling of the building. The approximate cost of "Remodeling - C" is greater than fifty (50) percent of the replacement cost of the building.
5. *Demolition*

---

<sup>1</sup>Leonard C. Romney. *Higher Education Facilities Inventory Classification Manual*. Technical Report 36, Final Review Edition, Boulder, Colorado; Western Interstate Commission for Higher Education, December 1972, p.43, 44.

Should be demolished or abandoned because the building is unsafe or structurally unsound, irrespective of the need for the space or the availability of funds for a replacement. This category takes precedence over categories 1, 2, 3 and 4. If a building is scheduled for demolition, its condition is recorded as "demolition" (5) regardless of its condition.

6. *Termination*

Planned termination or relinquishment of occupancy of the building for reasons other than safety or structural soundness, such as abandonment of temporary units or vacation of leased space. (See Title 5 definition, page 10.) This category takes precedence over categories 1, 2, 3 and 4. If a building is scheduled for termination in the current district *Five-Year Construction Plan*, its condition is recorded as "termination," (6) regardless of its condition.

**Construction Code:** The Code represent the five building types as shown in the Uniform Building Code<sup>2</sup>. Choose one of the following from the pull down menu:

- |    |                            |   |                           |
|----|----------------------------|---|---------------------------|
| 1. | <i>Type 1 Construction</i> | - | Fire resistive - concrete |
| 2. | <i>Type 2 Construction</i> | - | Heavy timber              |
| 3. | <i>Type 3 Construction</i> | - | Ordinary masonry          |
| 4. | <i>Type 4 Construction</i> | - | Light incombustible frame |
| 5. | <i>Type 5 Construction</i> | - | Wood frame                |

When two or more types of construction occur in the same building and are not separated by an unpierced wall of four-hour fire resistive construction, the entire building will be classified in the **least** resistive type of construction.

Any building which cannot be classified definitely as Type 1, 2, 3, 4 or 5 construction will be reported in the **least** fire-resistive class of the type to which it most nearly conforms.

**Year Built:** Enter the year the building construction was completed. (4 digit year format).

**Last Addition Year:** (Addition/Remodel) Last year in which an addition/remodel to the building took place (4 digit year format).

**Outside SQ FT:** Outside Gross Square Feet (OGSF) See **Reference Section B** for definition of outside gross square feet (7 character limit).

**Note:** Verify all outside gross square feet dimensions. If OGSF is altered all room entries within the building must reflect the new OGSF.

---

<sup>2</sup>Uniform Building Code, International Conference of Building Officials, Whittier, CA, 1991 (most widely used).

## Room Input Data

The process of entering room data begins similar to the addition of a building. First select District on the tree to the left, then select college/center from the tree on the left, then select building you wish to add/edit/delete a room in.

<b>Room Prefix:</b>	Enter up to two digits for the prefix. Optional use, use is not required.
<b>Room Number:</b>	Required entry. Enter up to four digits for the room number. Must be numbers only, no letters. Each college must provide a list of all rooms for each building of the college. (See <b>Reference Section E</b> for <i>Suggested Standard Patterns for Room Numbering</i> instructions.)
<b>Room Suffix:</b>	Enter up to two digits for the suffix. Optional use, use is not required.
<b>Department No.:</b>	Enter up to two numeric characters only. Department numbers are numbers to be selected by the district for its own use. Optional use, use is not required.
<b>Assigned Stations:</b>	Required Entry. Report the number of appropriate stations within a defined area that represents the best design application for a given educational program. The definition of a "station" is the total space of a facility to accommodate a student or person at a given assigned task (classroom - office - lab). Enter will accept up to 4 digits.
<b>Assigned SQ FT:</b>	Required Entry. The assignable square feet for any given area are obtained by measurement and computation. Please see <b>Reference Section B</b> , <i>Classification of Building Areas</i> for specific information. Entry will accept up to 5 digits.
<b>Program Number:</b>	Required Entry. The program number is entered via a pull down menu. The program number is a two-digit number for designating the general program use of the space. To illustrate: 11 is for General Academic Instruction, 32 is Community Service, and 47 is Course and Curricular classification or category definitions.
<b>Room Use:</b>	Required Entry. The room use is entered via a pull down menu. The actual physical characteristics of an office, a small conference room, a seminar room, and even a dormitory room are very similar, if not identical. The <b>use</b> of the room frequently is the distinguishing characteristic. . In order to use a designated room use code, the room space must be designed, constructed and equipped for the principal purpose so noted.
<b>TOP/CSS Code:</b>	Required Entry. The program related use is entered via a pull down menu. The menu contains the Classification Categories: 1) Taxonomy of Program (TOP) and 2) Service and Support (CSS) number. The classification or category number is an assigned number describing a known discipline or service. In all cases the number is a four-digit number representing classification or category definitions. Information detail on classification categories can be obtained from the System Office website at the following link <a href="http://www.cccco.edu/divisions/esed/aa_ir/CREDIT/credit_attachments/TopTax.doc">http://www.cccco.edu/divisions/esed/aa_ir/CREDIT/credit_attachments/TopTax.doc</a>



## DISTRICT INVENTORY CHECKLIST

1.  Are district, college/center, buildings accurately represented?
2.  Have the correct room types been entered?
3.  Are the correct Program, TOP or CSS numbers and categories entered?
4.  Has the FUSION Invalid TOP CODE Report been cleared of all issues?
5.  Are ASF (assignable square feet) and OGSF (outside gross square feet) measurements and relationships accurate and reasonable?
6.  Have all ASF measurements been made according to latest instructions?
7.  Has a second person checked the data for completeness and accuracy?
8.  Has the submit button in the *Space Inventory* FUSION database been activated prior to the **October 1 deadline**? Remember the report is to include all current and anticipated facility space in use as of December 31 of the current calendar year.
9.  Do you have any questions about any of the instructions? If so, please call your facilities specialist or the FACILITIES PLANNING UNIT at (916) 445-8283.

## **REFERENCE SECTION A**

### **Code Numbers for California Community College Districts, Colleges and Centers**

# CODE NUMBERS FOR CALIFORNIA COMMUNITY COLLEGE DISTRICTS, COLLEGES, AND CENTERS

## General

The System Office through the Management Information Services Division (MIS) has standardized district/college code designation.

The list that follows are recognized sites and FUSION Code numbers for inventoried facilities used for Capital Outlay purposes as of the latest revision to this manual (see the revision date for age of list). Additional sites may be added or deleted based on changes approved by the Board of Governors and CPEC. For the most current representation of recognized sites see the *Space Inventory* FUSION database for specific district data.

Please refer to this section (**Reference Section A**) of the manual for validation of the district/college designated code numbers. Please contact your facilities specialist of the FACILITIES PLANNING UNIT, (916) 445-8283, regarding any additions, corrections, and/or deletions to your district/college designations.

Review the data contained in this list as compared to the last *Space Inventory Report* provided by the state. Any changes or corrections should be noted using the FUSION *Space Inventory* database. All changes or corrections should be included in the next October *Space Inventory Report* 17 submittal.

<b>610</b>	<b>Allan Hancock CCD</b> 611 Allan Hancock College 612 Lompoc Valley Center	<b>930</b>	<b>Desert CCD</b> 931 College of the Desert 933 District Office
<b>620</b>	<b>Antelope Valley Joint CCD</b> 621 Antelope Valley College 622 Palmdale Center	<b>720</b>	<b>El Camino CCD</b> 721 El Camino College
<b>910</b>	<b>Barstow CCD</b> 911 Barstow College	<b>120</b>	<b>Feather River CCD</b> 121 Feather River College
<b>110</b>	<b>Butte-Glenn CCD</b> 111 Butte College	<b>420</b>	<b>Foothill-DeAnza CCD</b> 421 DeAnza College 422 Foothill College 423 Central Office 424 Middlefield Center
<b>410</b>	<b>Cabrillo CCD</b> 411 Cabrillo College 412 Watsonville Center	<b>440</b>	<b>Gavilan Joint CCD</b> 441 Gavilan College
<b>810</b>	<b>Cerritos CCD</b> 811 Cerritos College	<b>730</b>	<b>Glendale CCD</b> 731 Glendale College
<b>480</b>	<b>Chabot-Las Positas CCD</b> 481 Las Positas College 482 Chabot College 483 Hacienda District Office	<b>020</b>	<b>Grossmont-Cuyamaca CCD</b> 021 Cuyamaca College 022 Grossmont College 023 Grossmont District Office
<b>920</b>	<b>Chaffey CCD</b> 921 Chaffey College 922 Chino Campus Center 923 Ralph M. Lewis Center	<b>450</b>	<b>Hartnell Joint CCD</b> 451 Hartnell College
<b>820</b>	<b>Citrus CCD</b> 821 Citrus College	<b>030</b>	<b>Imperial CCD</b> 031 Imperial Valley College
<b>830</b>	<b>Coast CCD</b> 831 Coastline College 832 Golden West College 833 Orange Coast College 834 District Office	<b>520</b>	<b>Kern CCD</b> 521 Bakersfield College 522 Cerro Coso College 523 Porterville College 524 Delano Center 525 District Office 526 Southwest Center 527 Eastern Sierra Center
<b>710</b>	<b>Compton CCD</b> 711 Compton College	<b>220</b>	<b>Lake Tahoe CCD</b> 221 Lake Tahoe College
<b>310</b>	<b>Contra Costa CCD</b> 311 Contra Costa College 312 Diablo Valley College 313 Los Medanos College 314 District Office 315 San Ramon Valley Center	<b>130</b>	<b>Lassen CCD</b> 131 Lassen College
<b>970</b>	<b>Copper Mountain CCD</b> 971 Copper Mountain College	<b>840</b>	<b>Long Beach CCD</b> 841 Liberal Arts Campus 842 Pacific Coast Campus

<b>740</b>	<b>Los Angeles CCD</b>	<b>860</b>	<b>North Orange County CCD</b>
	741 Los Angeles City College		861 Cypress College
	742 Los Angeles Harbor College		862 Fullerton College
	743 Los Angeles Mission College		863 School of Continuing Education
	744 Los Angeles Pierce College		864 District Office & Anaheim Campus
	745 Los Angeles Southwest College	<b>430</b>	<b>Ohlone CCD</b>
	746 Los Angeles Trade-Technical College		431 Ohlone College
	747 Los Angeles Valley College		432 Newark-Ohlone Center
	748 East Los Angeles College	<b>950</b>	<b>Palo Verde CCD</b>
	749 West Los Angeles College		951 Palo Verde College
	74A District Office		952 Needles Center
<b>230</b>	<b>Los Rios CCD</b>	<b>060</b>	<b>Palomar CCD</b>
	231 American River College		061 Palomar College
	232 Cosumnes River College		062 Escondido Center
	233 Sacramento City College	<b>770</b>	<b>Pasadena Area CCD</b>
	234 District Office		771 Pasadena City College
	235 El Dorado Center		772 Community Skills Center
	236 Folsom Lake College	<b>340</b>	<b>Peralta CCD</b>
	237 Natomas Educational Center		341 Alameda, College of
<b>330</b>	<b>Marin CCD</b>		343 Laney College
	331 Indian Valley Campus		344 Merritt College
	334 Marin, College of		345 Berkeley City College
	336 District Office		346 District Office
<b>140</b>	<b>Mendocino CCD</b>	<b>870</b>	<b>Rancho Santiago CCD</b>
	141 Mendocino College		871 Santa Ana College
	142 Willits Center		872 District Office
	143 Lake County Center		873 Santiago Canyon College
<b>530</b>	<b>Merced CCD</b>	<b>160</b>	<b>Redwoods CCD</b>
	531 Merced College		161 Redwoods, College of the
	532 Los Banos Center		162 Del Norte Center
<b>050</b>	<b>Mira Costa CCD</b>		163 Mendocino Coast Center
	051 Mira Costa College	<b>880</b>	<b>Rio Hondo CCD</b>
	052 San Elijo Center		881 Rio Hondo College
	053 Community Learning Center	<b>960</b>	<b>Riverside CCD</b>
<b>460</b>	<b>Monterey Peninsula CCD</b>		961 Riverside City College
	461 Monterey Peninsula College		962 Norco Valley Center
	462 Ford Ord Center (Pending)		963 Moreno Valley Center
<b>850</b>	<b>Mt. San Antonio CCD</b>	<b>980</b>	<b>San Bernardino CC</b>
	851 Mt. San Antonio College		981 Crafton Hills College
<b>940</b>	<b>Mt. San Jacinto CCD</b>		982 San Bernardino Valley College
	941 Mt. San Jacinto College		983 District Office
	942 Menifee Valley Center		
<b>240</b>	<b>Napa CCD</b>		
	241 Napa Valley College		
	242 Upper Valley Center		

<b>070</b>	<b>San Diego CCD</b>		
	071	San Diego City College	
	072	San Diego Mesa College	
	073	San Diego Miramar College	
	074	San Diego District Office	
	075	San Diego Centre City Center	
	076	West City Center, Point Loma Campus	
	077	San Diego Ed. Cultural Complex	
	078	North City Center	
	079	West City Center, Clairemont Campus	
	07A	San Diego Mid City Center	
<b>360</b>	<b>San Francisco CCD</b>		
	361	San Francisco, City College of	
	362	John Adams CC Center	
	363	Downtown CC Center	
	364	Aleman CC Center	
	366	John O'Connell Trade Tech Center	
	367	Mission CC Center	
	368	District Office Building	
	369	Southeast CC Center	
	36A	Airport CC Center	
	36B	Chinatown/North Beach CC Center	
<b>550</b>	<b>San Joaquin Delta CCD</b>		
	551	San Joaquin Delta College	
<b>470</b>	<b>San Jose Evergreen CCD</b>		
	471	Evergreen Valley College	
	472	San Jose City College	
	473	District Office	
<b>640</b>	<b>San Luis Obispo County CCD</b>		
	641	Cuesta College	
	642	North County Center	
<b>370</b>	<b>San Mateo County CCD</b>		
	371	Cañada College	
	372	San Mateo, College of	
	373	Skyline College	
	374	District Office	
<b>650</b>	<b>Santa Barbara CCD</b>		
	651	Santa Barbara City College	
	653	Wake Center	
	654	Schott Continuing Ed. Center	
<b>660</b>	<b>Santa Clarita CCD</b>		
	661	College of the Canyons	
	662	Canyon Country Educational Center	
<b>780</b>	<b>Santa Monica CCD</b>		
	781	Santa Monica City College	
<b>560</b>	<b>Sequoias CCD</b>		
	561	Sequoias, College of the	
	562	Tulare Center	
<b>170</b>	<b>Shasta-Tehama-Trinity Jt. CCD</b>		
	171	Shasta College	
<b>270</b>	<b>Sierra Jt. CCD</b>		
	271	Sierra College	
	272	Western Nevada County Center	
<b>180</b>	<b>Siskiyou CCD</b>		
	181	Siskiyou, College of the	
<b>280</b>	<b>Solano CCD</b>		
	281	Solano College	
	282	Vacaville Center	
<b>260</b>	<b>Sonoma County CCD</b>		
	261	Santa Rosa Junior College	
	262	Public Safety Training Center	
	263	Petaluma Center	
<b>890</b>	<b>South Orange County CCD</b>		
	891	Saddleback College	
	892	Irvine Valley College	
<b>090</b>	<b>Southwestern CCD</b>		
	091	Southwestern College	
	092	Otay Mesa Center	
<b>570</b>	<b>State Center CCD</b>		
	571	Fresno City College	
	572	Reedley College	
	573	District Office	
	574	Career & Technology Center	
	575	Madera Center	
	576	Willow/International Center	
<b>680</b>	<b>Ventura CCD</b>		
	681	Moorpark College	
	682	Oxnard College	
	683	Ventura College	
	684	District Office	
<b>990</b>	<b>Victor Valley CCD</b>		
	991	Victor Valley College	
<b>580</b>	<b>West Hills CCD</b>		
	581	West Hills College - Coalinga	
	582	West Hills College - Lemoore	
	583	North District Center	
<b>690</b>	<b>West Kern CCD</b>		
	691	Taft College	
<b>490</b>	<b>West Valley CCD</b>		
	492	Mission College	
	493	West Valley College	
	494	District Office	

**590 Yosemite CCD**  
591 Columbia College  
592 Modesto Jr. College  
593 District Office

**290 Yuba CCD**  
291 Yuba College  
292 Lake County Center  
293 Woodland College

## **REFERENCE SECTION B**

### **Classification of Building Areas**



# CLASSIFICATION OF BUILDING AREAS

The validity of the California Community Colleges Facility Inventory is based on consistent application of definitions to building areas and to the accurate classification and measurement of those areas. The data are subject to the scrutiny of a campus audit and should be able to withstand tests of accountability.

FUSION has a Unclassified Space Report that should be run and the space that is listed in the report should be reviewed and identified as whether it will be included in the *Space Inventory* or considered non-assignable space and excluded from the report. Space that should be included in the *Space inventory* shall be entered using the following classification criteria.

## Classification of Campus Space

The measurement of building areas is organized in the following manner:

	Definition	Examples
1.	Gross Area	Figure 1
2.	Assignable Area	Figure 2
3.	Non-assignable Area	
3.1	Circulation	Figure 3
3.2	Custodial Area	Figure 4
3.3	Mechanical Area	Figure 5
3.4	Structural Area	Figure 6

Each major area classification is accompanied by a definition, basis of measurement, description, limitations, supplementary information and an illustrative example.

Calculations of **Diagram of Building Areas** includes determination of total outside gross building area dimensions by section. All building areas including covered walkways and overhangs are to be calculated in the totals. See Figure 7.

## Classification of Off-Campus Space

Classroom, laboratory and any other chargeable off-campus space owned, leased or rented and fully controlled, where Weekly Student Contact Hours (WSCH) are produced, **must be included** in the inventory. Consult the System Office for direction where WSCH is produced in unaccounted space.

# DEFINITIONS OF BUILDING AREAS

## 1. Gross Area

- a. *Definition:* The sum of the floor areas of the building included within the outside faces of exterior walls for all stories or areas that have floor surfaces.
- b. *Basis for Measurement:* Gross area is computed by measuring from the outside face of exterior walls, disregarding cornices, pilasters, buttresses, etc., which extend beyond the wall face. Measured in terms of gross square feet (GSF).
- c. *Description:* In addition to all the internal floor space covered above, gross area includes basements (except unexcavated portions), attics, garages, enclosed porches, penthouses, mechanical-equipment floors, lobbies, mezzanines, all balconies (inside or outside) utilized for operational functions, and corridors, provided they are within the outside face lines of the building. Roofed loading or shipping platforms are included, whether within or outside the exterior face lines of the building. Stairways, elevator shafts, mechanical-service shafts and ducts are to be counted as gross area on each floor through which the shaft passes.
- d. *Limitations:* Exclude open courts and light wells or portion of upper floors eliminated by rooms or lobbies that rise above single-floor ceiling height.
- e. *Supplementary:* Covered exterior areas or overhang attached and/or related to the building of one floor or more are counted at one-half value.

Mezzanines, stacks and interior balconies are included in the total, but only for the floor area they represent.

Penthouses and attic space with minimum headroom height (6'6") are included.

A room extending through more than one floor is counted only once at the level on which its floor occurs.

Shed structures, unenclosed, are counted on the basis that the support posts for the roof are functionally equivalent to an outside wall or partition.

Stair, elevator, utility core and similar shafts are considered as floor area at each level.

Terraces (uncovered exterior), swimming pools, loading docks, courts, light wells, roof decks and covered walks between buildings are not included.

All building space that is unfinished is classified under **070 Facilities Not in Service** until completed, and should be counted at one-half value for gross square feet. However, excavated basement areas not developed or with a finished floor are not to be counted as gross space.

Unexcavated areas in basements and undeveloped attic spaces (crawl spaces) are not included in gross area determination.

- f. See **Figures 1A and 1B, Gross Area**, for examples.

## 2. Assignable Area

- a. *Definition:* The sum of all areas on all floors of a building assigned to, or available for assignment to an occupant, including every type of space functionally usable by an occupant (excepting those spaces defined as circulation, custodial, mechanical and structural areas).
- b. *Basis for Measurement:* All assignable areas are computed by measuring from the inside finishes of surfaces that form the boundaries of the designated areas. Do not include **unusable** areas having less than 6'6" clear headroom. Express in square feet to the nearest whole number.
- c. *Description:* Included are space subdivisions for offices, classrooms, laboratories, seminar and conference rooms, libraries, file rooms, storage rooms, etc., including those for special purposes (e.g., auditoriums, cafeterias, TV studios, faculty and student locker and shower rooms, maintenance and repair shops, garages) which can be put to useful purposes in accomplishing the mission of the institution.
- d. *Limitations:* Deductions are not to be made for necessary building columns and projections.
- e. *Supplementary:* Questionable assignable areas are listed below alphabetically for easy identification. Interior areas, individualized areas, private areas and service units within assignable areas are deemed usable and classified assignable. Illustrations:
  - (1) Public toilets are non-assignable, but a toilet in the executive suite is assignable.
  - (2) Public hallways are non-assignable, but a restricted hallway within a home economics suite, administrative suite or learning resource center is assignable.
  - (3) Janitors' closets are non-assignable, but custodial locker rooms are assignable.

Assignable areas that are often mistaken as non-assignable include:

- Airplane hangars
- Alcoves and similarly recessed areas
- Book elevators and conveyors
- Built-in free-standing furniture and equipment
- Corridors within departmental suites
- Custodial and grounds buildings, departmental storage areas, and shops
- Custodial locker rooms
- Custodial offices
- Dressing rooms, locker rooms, washrooms and showers for academic activities or performers
- Greenhouses and headhouses
- Heating and ventilating equipment rooms within structurally isolated heating plants
- Institutional garage and automotive vehicular service and storage areas
- Lathhouses
- Laundry rooms in residence halls and apartments
- Library stack areas including aisles
- Loading and receiving docks, interior
- Lobbies which are **internal** corridors serving operational functions, such as reception and waiting
- Lunchrooms
- Mechanical areas serving separate special laboratories only
- Parking areas in non-parking structure buildings
- Reception and waiting rooms
- Screenhouses
- Social rooms in residence halls

Stairwells and elevators within book stacks  
Theater green rooms  
Toilets for (individualized, private access)  
    Residence hall and apartment occupants  
    Clinic outpatients  
    Hospital inpatients  
    Executive suites  
    Instructional and research activities, as in controlled environment  
        laboratories and gymnasiums  
Transformers, switchgear, generator rooms within structurally  
isolated substations or generating plants.

f. See **Figures 2A and 2B, Assignable Area**, for examples.

### 3. Non-Assignable Area

That portion of the building area not available for assignment to building occupants, but necessary for general operation. By definition, non-assignable areas consists exclusively of circulation, custodial, mechanical and structural areas.

#### 3.1. Circulation Area

- a. *Definition:* Required for physical access to some subdivision of space whether directly bounded by partitions or not.
- b. *Basis for Measurement:* Computed by measuring from the inner faces of walls or partitions that enclose horizontal spaces used for such purposes. Deductions are not made for necessary building columns and minor projections. Do not include **unusable** areas having less than 6'6" clear headroom.
- c. *Description:* Include but not limited to corridors, elevator shafts, escalators, fire towers, stairways, loading platforms, elevator lobbies and tunnels and bridges.
- d. *Limitations:* When determining corridor areas, only horizontal spaces required for general access is included - not aisles used only for circulation within office suites, auditoriums or other working areas. Deductions are not made for necessary building columns and projections.
- e. *Supplementary:*

Non-assignable areas:

Display facilities and lockers in corridors  
Lobbies for general circulation  
Parking structures, separate  
Public toilets

f. See **Figures 3A and 3B, Non-Assignable Area: Circulation Area**, for examples.

#### 3.2. Custodial Area

- a. *Definition:* The sum of all areas of a building used for its protection, care and maintenance.

- b. *Basis for Measurement:* Measured from the inside surfaces of enclosing walls or permanent partitions. Deductions are not made for necessary building columns and minor projections. Do not include **unusable** areas with less than 6'6" clear headroom.
- c. *Description:* Includes such areas as trashrooms, guardrooms, custodial rooms, custodial locker rooms and custodial supply rooms.
- d. *Limitations:* Does not include central physical-plant shop areas, or special-purpose storage or maintenance rooms, such as linen closets and maid rooms in residence halls.
- e. See **Figures 4A and 4B, Non-Assignable Area: Custodial Area**, pages 42 and 43, for examples.

### 3.3. Mechanical Area

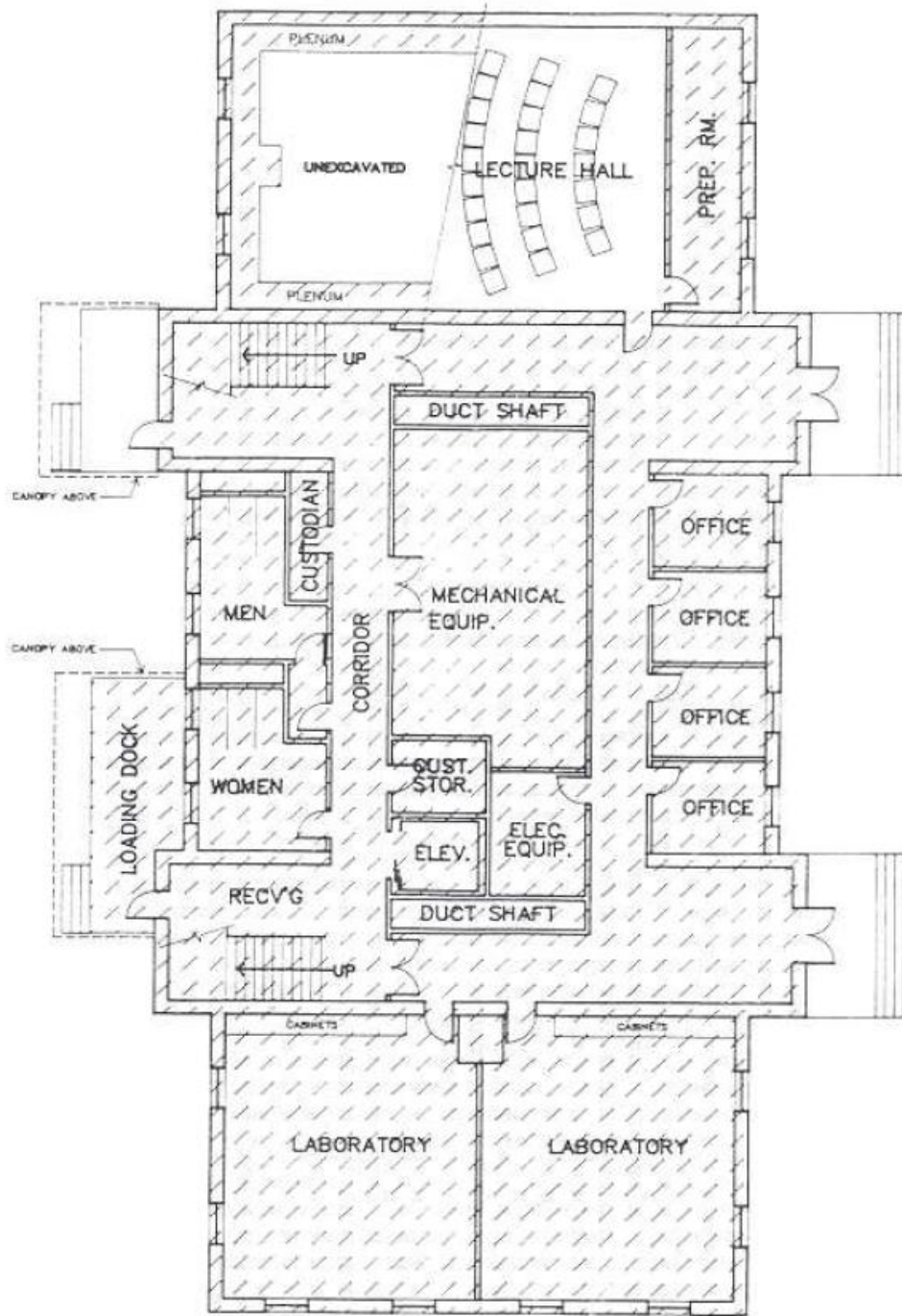
- a. *Definition:* That portion of the gross area designed to house mechanical equipment, utility services and nonprivate toilet facilities.
- b. *Basis for Measurement:* Computed by measuring from the inner faces of the walls, partitions or screens which enclose such areas. Do not include **unusable** areas with less than 6'6" clear headroom.
- c. *Description:* Includes, but not limited to, mechanical areas in central utility plants, air-duct shafts, boiler rooms, fixed mechanical and electrical equipment rooms, fuel rooms, mechanical-service shafts, meter and communication closets, service chutes, stacks and nonprivate toilet rooms (custodial and public).
- d. *Limitations:* Deductions are not made for necessary building columns and projections.
- e. See **Figures 5A and 5B, Non-Assignable Area: Mechanical Area**, pages 44 and 45, for examples.

### 3.4. Structural Area

- a. *Definition:* Construed to mean that portion of the gross area which cannot be occupied or put to use because of structural building features.
- b. *Basis for Measurement:* Precise computation by direct measurement is not contemplated under these definitions. Generally determined by assuming it to be the residual area after the assignable, circulation, custodial and mechanical areas are subtracted from the gross area.
- c. *Description:* Examples of building features normally classified as structural area are exterior walls, fire walls and permanent partitions or comparable portions of a building.
- d. See **Figures 6A and 6B, Non-Assignable Area: Structural Area**, pages 46 and 47, for examples.

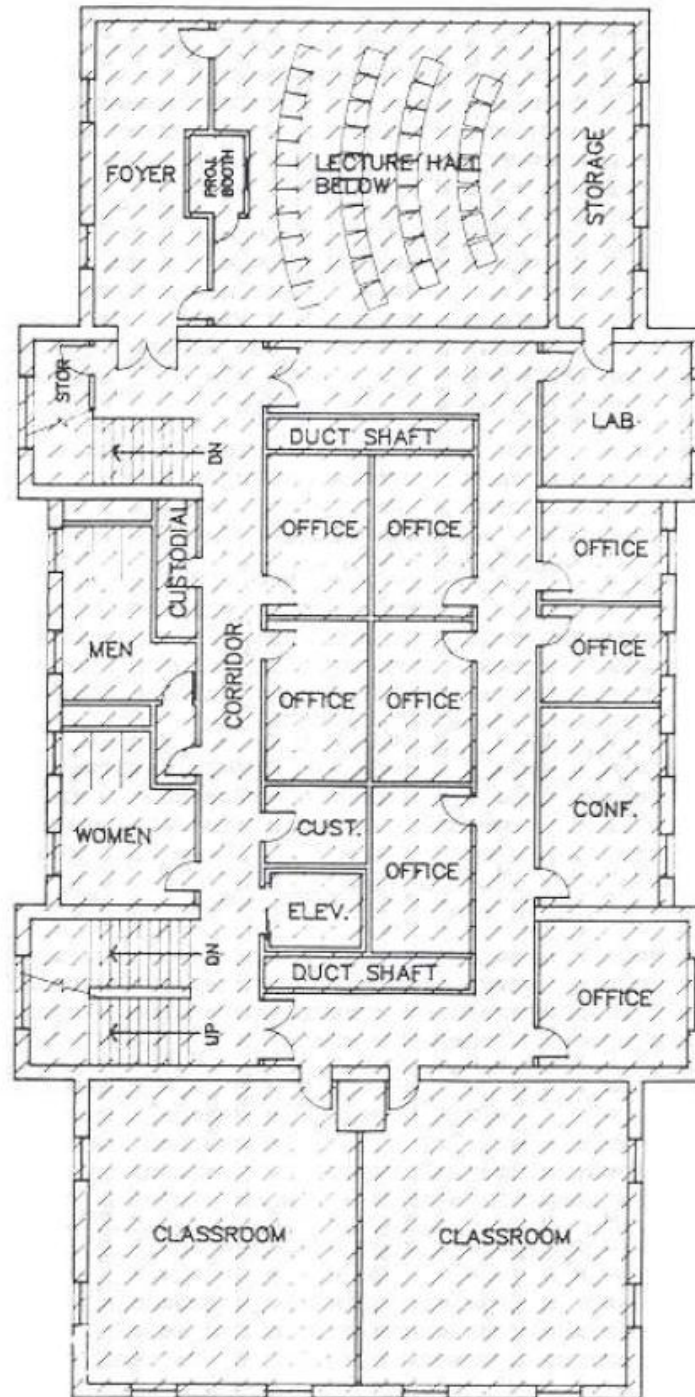
# Building Area Figures

Figure 1A. Gross Area



First Floor

Figure 1B. Gross Area



Second Floor



Figure 2A. Assignable Area

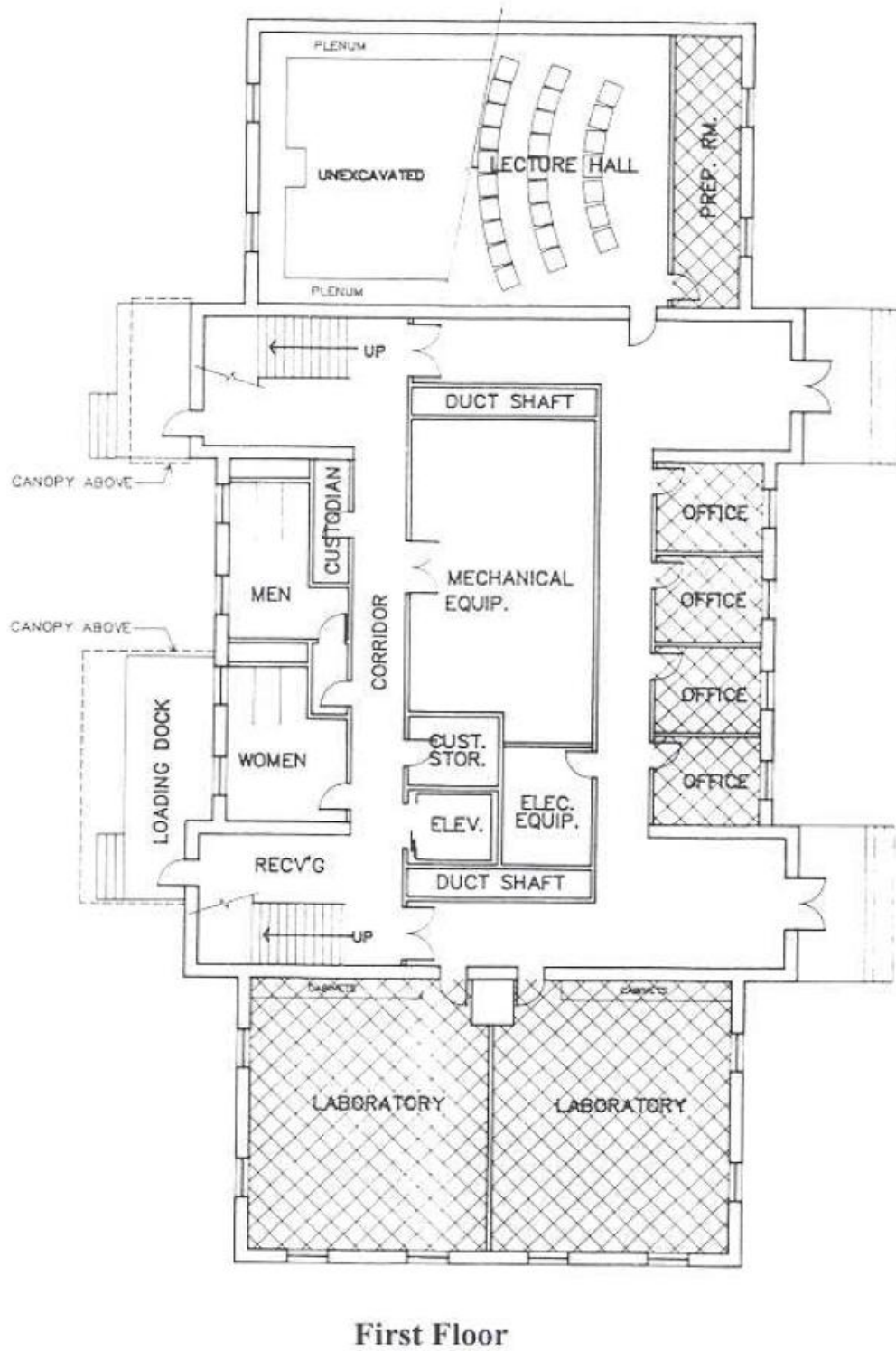
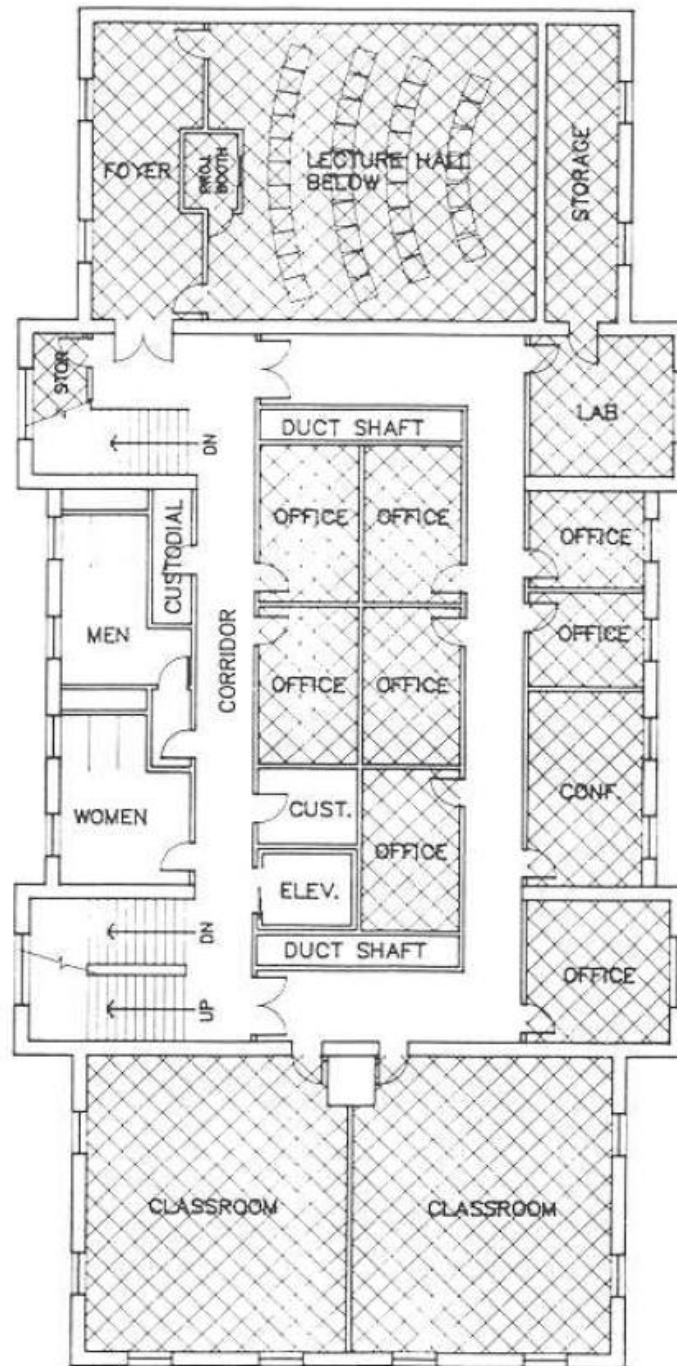
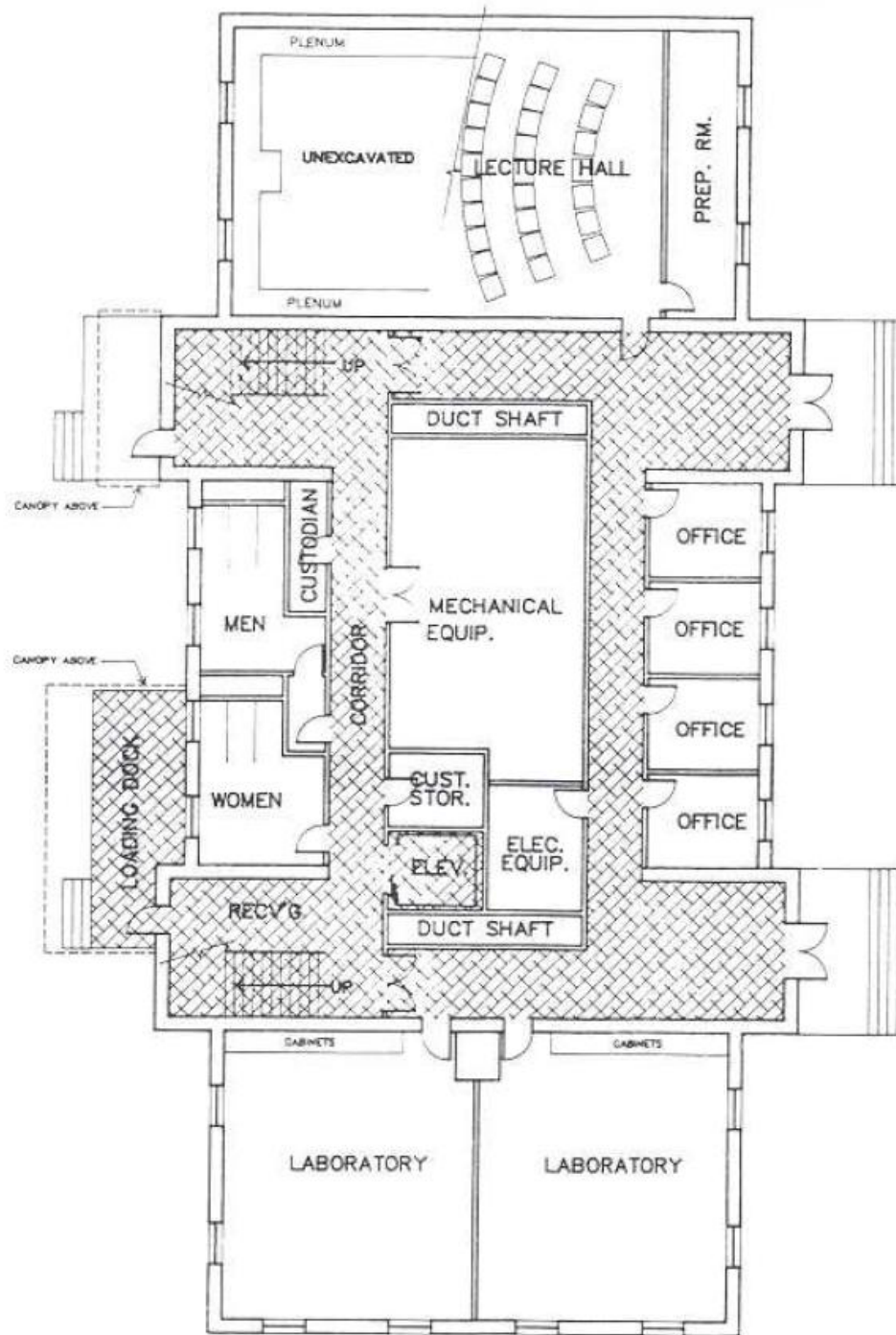


Figure 2B. Assignable Area



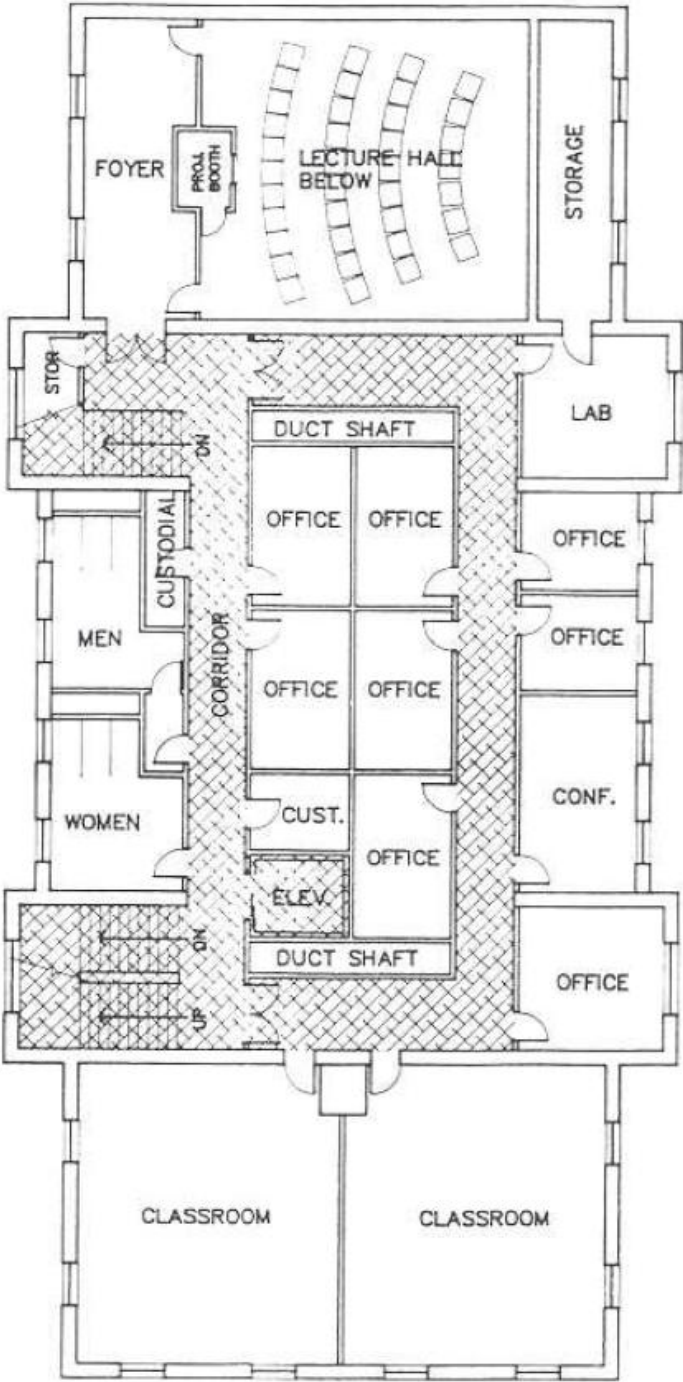
Second Floor

Figure 3A. Non-Assignable Areas: Circulation Area



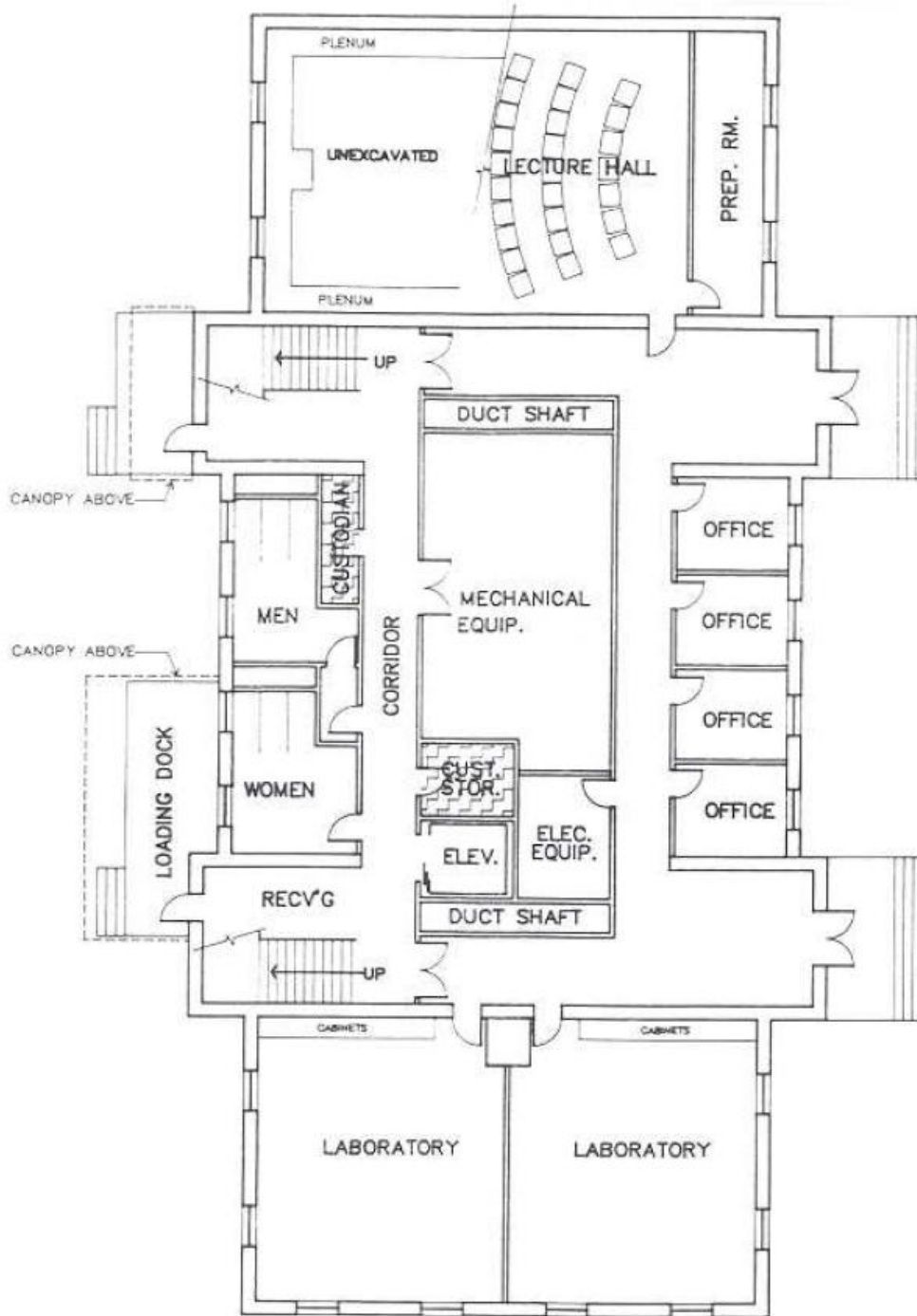
First Floor

Figure 3B Non-Assignable Areas: Circulation Area



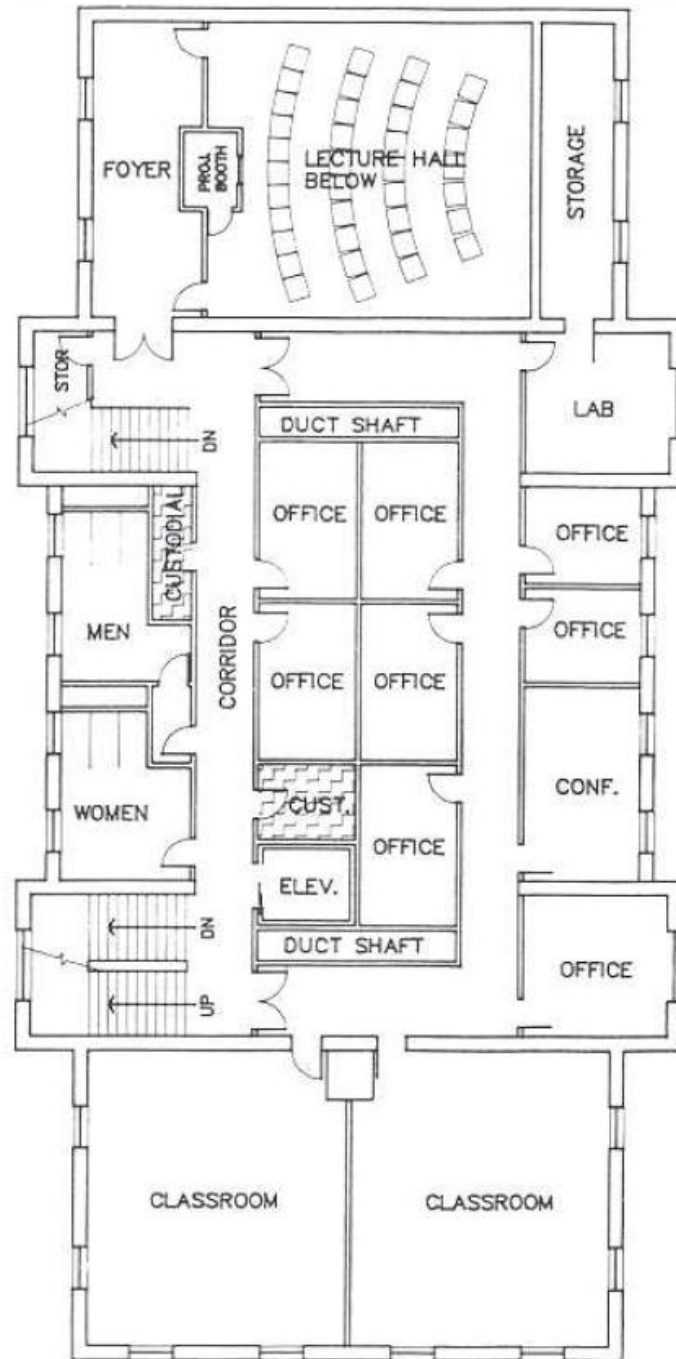
Second Floor

Figure 4A. Non-Assignable Area: Custodial Area



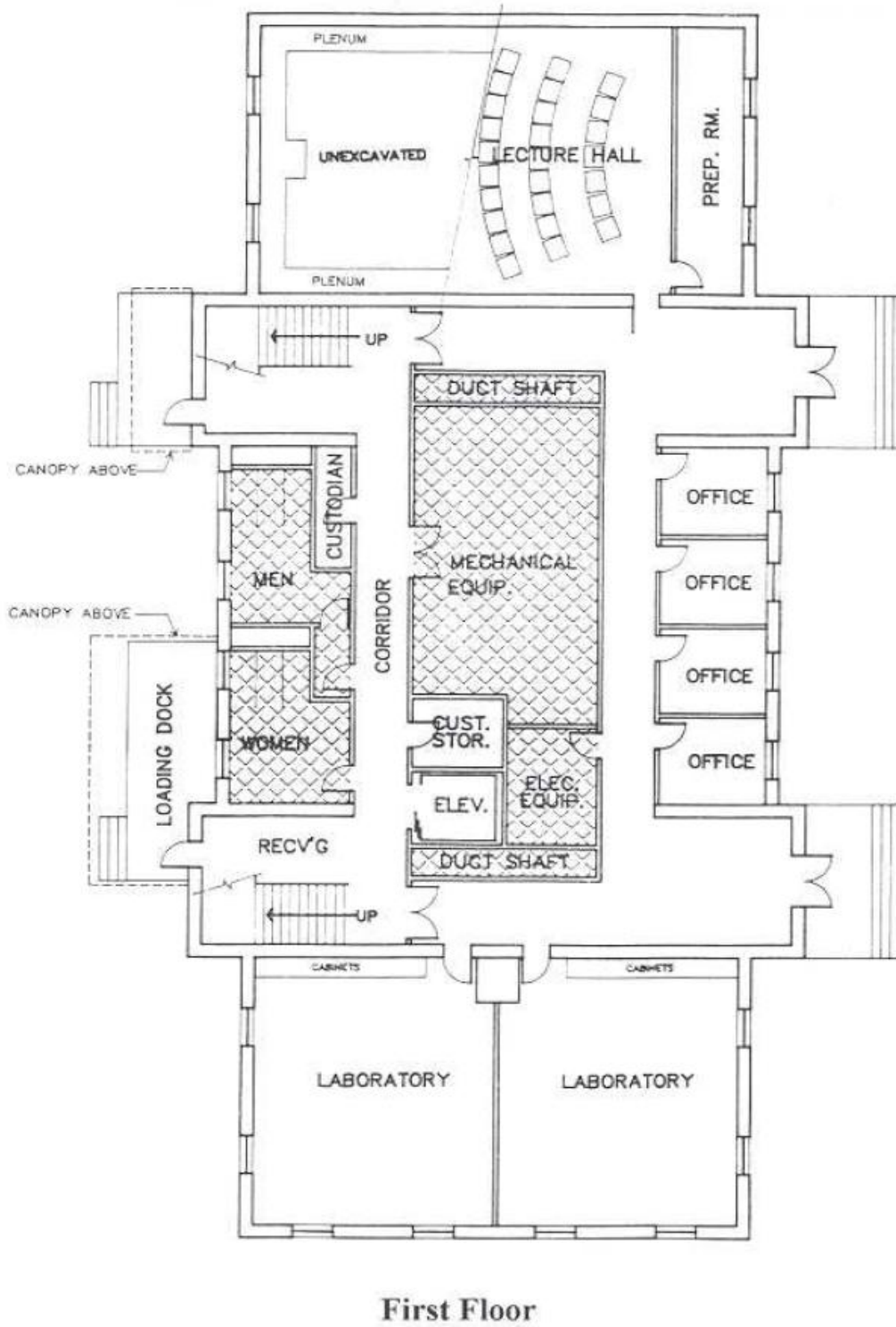
First Floor

Figure 4B. Non-Assignable Area: Custodial Area



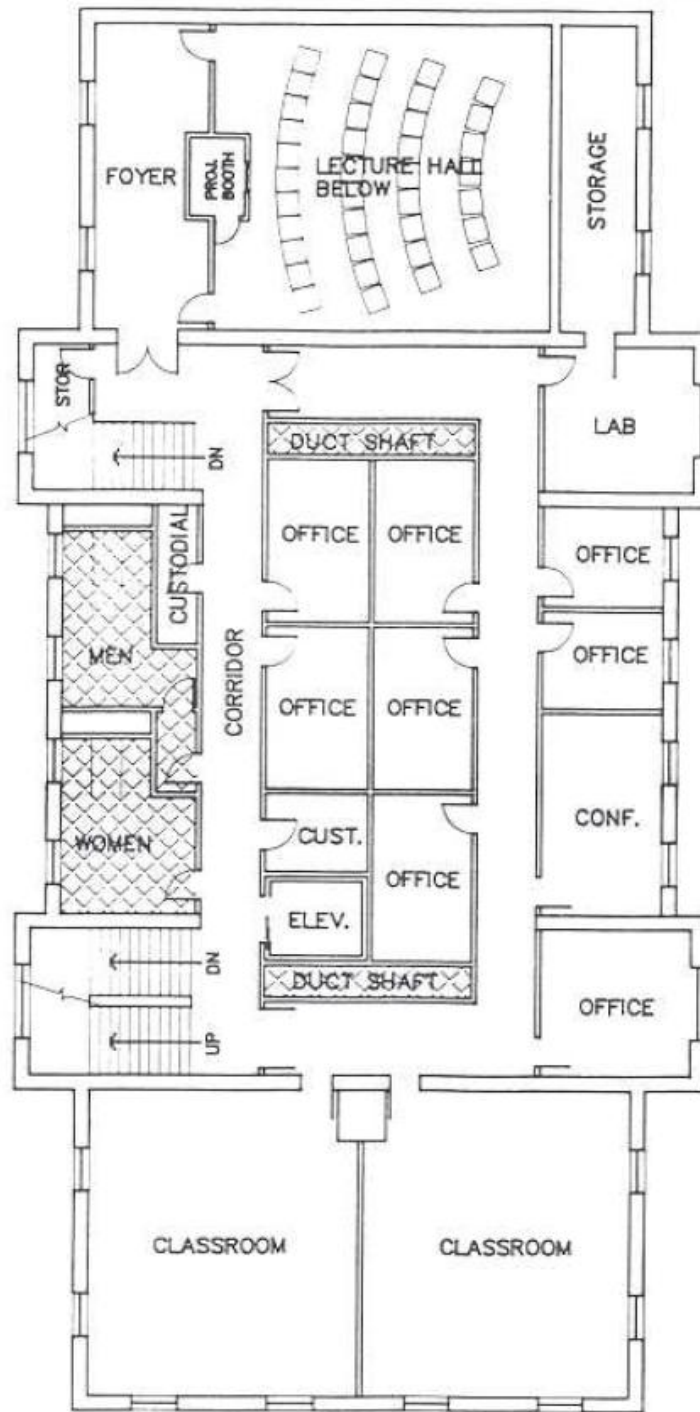
Second Floor

Figure 5A. Non-Assignable Area: Mechanical Area



First Floor

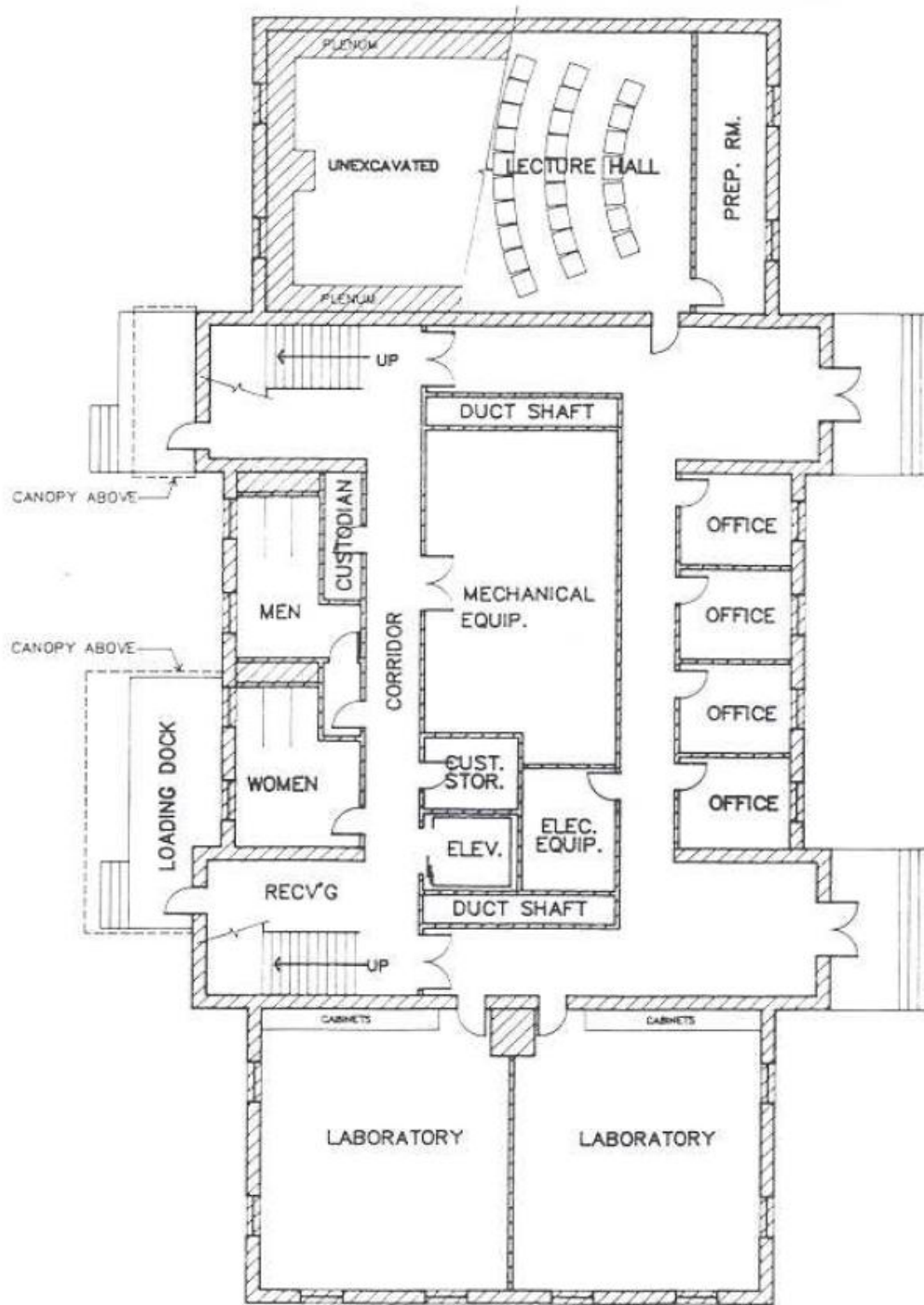
Figure 5B. Non-Assignable Area: Mechanical Area



Second Floor

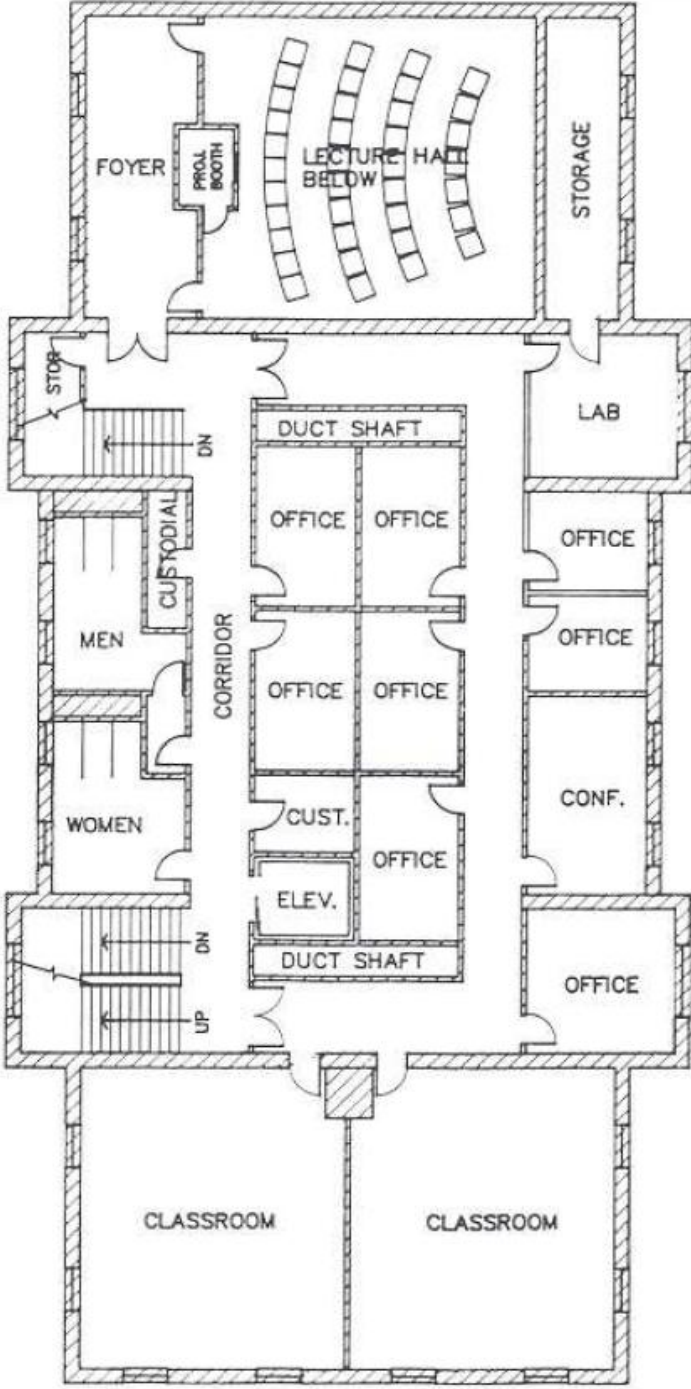


Figure 6A. Non-Assignable Area: Structural Area



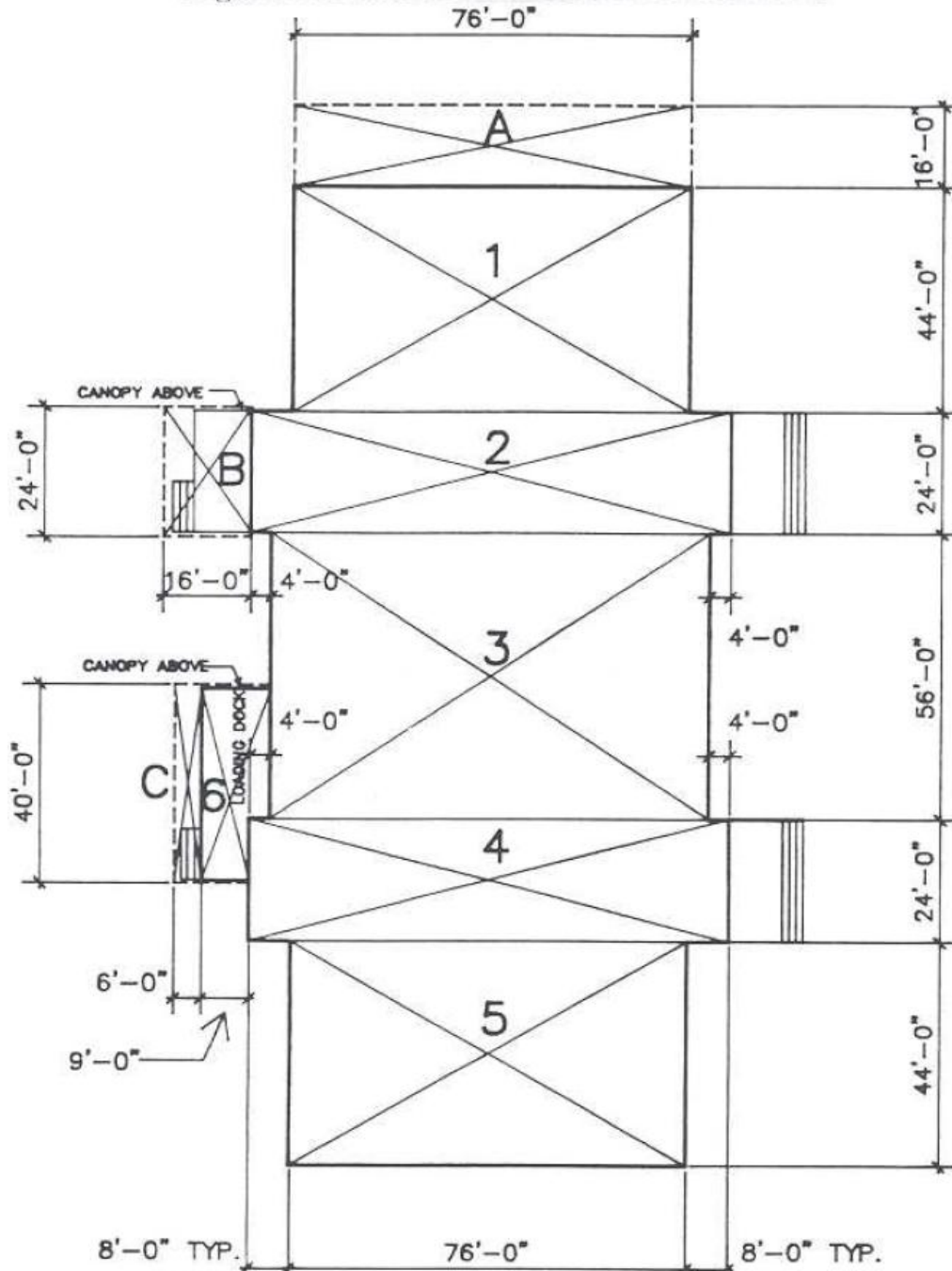
First Floor

Figure 6B. Non-Assignable Area: Structural Area



Second Floor

Figure 7. DIAGRAM OF BUILDING AREAS



BUILDING AREAS	1	76'-0" x 44'-0"	3,344 s.f.
	2	92'-0" x 24'-0"	2,208 s.f.
	3	84'-0" x 56'-0"	4,704 s.f.
	4	92'-0" x 24'-0"	2,208 s.f.
	5	76'-0" x 44'-0"	3,344 s.f.
	6	9'-0" x 40'-0"	360 s.f.
COVERED WALKS	A	76'-0" x 16'-0" x 1/2	608 s.f.
& OVERHANGS	B	16'-0" x 24'-0" x 1/2	192 s.f.
	C	6'-0" x 40'-0" x 1/2	120 s.f.
TOTAL OUTSIDE GROSS BUILDING AREA			17,088 s.f.

# **REFERENCE SECTION C**

## **Program Number Structure**



# PROGRAM NUMBER STRUCTURE

## Purpose of Program Structure

Function and/or object may classify facilities of the California Community Colleges Space Inventory. Classification is that of the standardized *Taxonomy of Programs* (TOP)<sup>3</sup>. TOP serves three purposes:

- Enables districts to utilize a standardized taxonomy;
- Provides the capability for interstate and federal reporting;
- Attains a rigorous classification of facilities.

The most useful outcomes are uniformity when used; flexibility for expanded reporting, and compatibility for comparative reporting.

**Note:** The TOP numbers used for the *Space Inventory* are the same TOP numbers used for the Course Classification System.

## Organization of Program Number Structure and TOP Code Use

The program structure consists of a two-section system. The first section *Program Number* consists of two digits.

The second section *Classification Number* consists of four digits and has two parts. The first part is the *Taxonomy of Programs* (TOP), and is used with a program number that is for **instruction or instruction related**. The second part is *Classification of Service and Support* (CSS) and is used for **support services** to the instructional program.

For a detailed explanation of the Taxonomy of Programs use please use the link to the Chancellor's Office Reference Materials Section of our website at [http://www.cccco.edu/divisions/esed/aa\\_ir/CREDIT/credit\\_attachments/TopTax6\\_rev\\_07.doc](http://www.cccco.edu/divisions/esed/aa_ir/CREDIT/credit_attachments/TopTax6_rev_07.doc).

---

<sup>3</sup>California Community Colleges. *Taxonomy of Programs (TOP)*. February, 2004, Sacramento, California.

# PROGRAM NUMBERS

- 11 General Academic Instruction
- 12 Occupational and Vocational Instruction
- 13 Special Session Instruction
- 14 Extension Instruction (for credit)
  
- 20 Programs in this classification are not used by California Community Colleges
  
- 31 Community Education
- 32 Community Service
- 33 Cooperative Extension Service
  
- 41 Libraries
- 42 Museums and Galleries
- 43 Audio/Visual Services
- 44 Computing Support
- 45 Ancillary Support
- 46 Academic Administration and Personnel Development
- 47 Course and Curriculum Development
  
- 51 Social and Cultural Development
- 52 Supplementary Educational Services
- 53 Counseling and Career Guidance
- 54 Financial Aid
- 55 Student Support
  
- 61 Executive Management
- 62 Fiscal Operations
- 63 General Administrative Services
- 64 Logistical Services
- 65 Physical Plant Operations
- 66 Faculty and Staff Services
- 67 Community Relations
  
- 71 Institutional Operations
- 72 Outside Agencies





**Reference Section C.1.**

**Classification Categories:  
Service and Support (CSS)**

## INSTRUCTIONS FOR THE USE OF SERVICE AND SUPPORT CATEGORY NUMBERS

All college entries are to be made in categories ending in numbers such as 6010, 6020 and 6030 under "6000 Instructional Support." The number "6000" is **not** to be used. It is a general category designation used only for describing the various sub-group numbers that belong under this main service category. It is **not** a functional category. Any entries placed in a heading that ends in a double zero such as "6000" will be reprogrammed to delete the entry and it will appear under an appropriate heading.

FUSION has been programmed with a pull down menu to assist you in selecting the appropriate CSS Code for the space.

**Note:** The one exception to these instructions is "9600" for "Unassigned." No subprogram categories have been provided. The amount of space reported in this category will be minimal.

*Service and Support Category Numbers* contain the 6000 numbers. Therefore, **no** 6000 classification number should be used with Program Numbers 11, 12, 13 or 14, which are instruction alternatives. (See **Reference Section C.**)

If there is a question about any of the instructions, please call a FACILITIES PLANNING AND UTILIZATION UNIT Specialist at (916) 445-8283.

# CLASSIFICATION CATEGORIES

## Service and Support

### Summary List

#### **6000 Instructional Administration**

- 6010 Academic Administration
- 6020 Course and Curriculum Development
- 6030 Administrative Data Processing Activities
- 6040 Computer-Assisted Instruction
- 6099 Other Instructional Administration

#### **6100 Instructional Support Services**

- 6110 Learning Center (Learning Resource Center)
- 6120 Library
- 6130 Media Services
- 6140 Museums and Galleries
- 6199 Other Instructional Support Services

#### **6200 Admissions and Records**

- 6210 Registrations, Transfers, Transcripts, Certifications
- 6220 Student Records, Statistics and Publications
- 6230 Admissions Activities
- 6299 Other Admissions and Records

#### **6300 Counseling and Guidance**

- 6310 Counseling Services
- 6320 Placement Services
- 6399 Other Counseling and Guidance

#### **6400 Other Student Services**

- 6420 Disabled Students Programs and Services (DSPS)
- 6430 Extended Opportunity Programs and Services (EOPS)
- 6440 Health Services
- 6450 Student Personnel Administration
- 6460 Financial Aid
- 6470 Job Placement Services
- 6480 Veterans Services
- 6491 Student Transportation
- 6492 Foreign Student Services
- 6499 Other Student Services

#### **6500 Maintenance and Operation of Plant**

- 6510 Building Maintenance and Operation Support
- 6530 Custodial Services
- 6550 Grounds Maintenance and Repairs
- 6570 Utilities
- 6599 Other Maintenance and Operation of Plant

**6600 Planning and Policy Making**

- 6610 Institutional Research
- 6620 Management Planning Functions
- 6630 Instructional Planning
- 6699 Other Planning and Policy Making

**6700 General Institutional Support Services**

- 6710 Community Relations
- 6720 Fiscal Operations
- 6730 Human Resources Management
- 6750 Staff Development
- 6760 Staff Diversity
- 6770 Logistical Services
- 6780 Management Information Services
- 6791 General Administration Services
- 6799 Other General Institutional Support Services

**6800 Community Services**

- 6810 Community Recreation
- 6820 Community Service Classes
- 6830 Community Use of Facilities
- 6899 Other Community Services

**6900 Ancillary Services**

- 6910 Bookstore
- 6920 Child Development Centers
- 6930 Farm Operations
- 6940 Food Services
- 6950 Parking Services
- 6960 Students and Co-curricular Activities
- 6970 Student Housing (Dormitories)
- 6999 Other Ancillary Services

**7000 Auxiliary Operations**

- 7010 Auxiliary Classes
- 7091 Noninstitutional Activity
- 7099 Other Auxiliary Operations

**7100 Physical Property and Related Acquisitions**

- 7110 Current Operations
- 7120 Capital Outlay Projects

7199 Other Physical Property and Related Acquisitions

**9600 Unassigned**

## SERVICE CATEGORIES

### **6000 Instructional Administration**

This function consists of the administrative support and management of instructional activities. Typically included are deans of instruction, division chairpersons and their supporting staff areas.

Also include academic administration and course development areas that are divisional or institution-wide in use. Spaces devoted to curriculum committees are an example.

Coordinators, supervisors and departmental chairs and their facilities should not be reported here, but in the appropriate TOP categories to which their efforts are directed.

### **6010 Academic Administration**

Campus-wide academic administration offices and headquarters of any instructional unit above the department level with teaching programs broader than those included in any single category or subject field numbered 0100 through 4930. Included are Dean of Academic Division or Dean of Arts and Sciences.

### **6020 Course and Curriculum Development**

An instructional department with a substantial portion of its activities designed to improve or significantly add to instructional offerings.

### **6030 Administrative Data Processing Activities**

Central administrative functions related to general college and/or district activities. Instruction related functions should not be included.

### **6040 Computer-Assisted Instruction**

Included categories relate to computer-assisted instruction for course and curricular development. Administrative functions should not be included.

### **6099 Other Instructional Administration**

### **6100 Instructional Support Services**

The library learning resource center generally includes three functions:

- library (traditional) (print core),
- media services (AV, TV and nonprint core),
- learning center, including nontraditional approaches to learning such as programmed instruction, a relatively new function.

Museums and galleries may or may not be included in the library learning resource center, but may be regarded as a related function. Instructional services related to a specific discipline and accounted for under a TOP category are not included. Media services would exclude the audio equipment operation within a language lab that should be accounted for under a TOP category.

### **6110 Learning Center (*Learning Resource Center*)**

Category includes that part of a library or a learning resource center that contains facilities and services for the nontraditional approaches to learning, such as programmed instruction, not directly related to a particular discipline and available to all students on a nonscheduled basis.

The learning resource center may contain audio-visual equipment, slides, films, records and programmed materials to assist students and may be located within the college library. Examples of activities include, but are not limited to, tutorial, self-study, programmed instruction and language laboratory.

General use activities in the learning resource center may generate full-time equivalent students (FTES).

**6120 Library** (*Print Core*)

Library includes the traditional activities associated with the reading or study room, stacks, cataloging services and collections of published materials. Activities associated with the main or central library are illustrative. This category does not include classroom or laboratory book collections acquired by individuals or groups not accountable to the main or central library.

**6130 Media Services** (*AV, TV, and/or Nonprint Core*)

The nonprint core activities include audio visual, TV and the production services such as graphics, photography, equipment and materials circulation, equipment maintenance, studios, shops, storage and workrooms. Services are campus-wide.

**6140 Museums and Galleries**

Museums and galleries are related to the collection, preservation and exhibition of historical materials, art objects, scientific displays and other related functions.

**6199 Other Instructional Support Services**

**6200 Admissions and Records**

Included in this function are the resources devoted to student admissions and evaluations, transfer evaluations, registrations, transcripts, degree certifications, student records, statistics and publications.

**6210 Registrations, Transfers, Transcripts, Certifications**

Functions include registrations, transfers, transcripts and certifications. In small colleges it is possible that all functions in this category can be placed under a single heading. If this is the case, include under category 6210.

**6220 Student Records, Statistics and Publications**

Functions include records, statistics, publications and any other related functions. If functions are diversified, two headings may be used, especially in larger colleges. If all functions are grouped, see category 6210.

**6230 Admissions Activities**

This category applies to admissions functions of greater detail or scope than are readily identified under 6210 or 6220. Size of an admissions function may dictate need for this additional category.

**6299 Other Admissions and Records**

**6300 Counseling and Guidance**

This function includes the counseling service, career guidance and placement services for the student body. Excluded is any informal counseling or "advising" by teaching personnel.

**6310 Counseling Services**

Category is intended for college-counseling services commonly grouped centrally on campus.

**6320 Placement Services**

Includes the placement services that frequently complement the guidance services. Segregate functions into separate categories, counseling and placement, if so organized. If services are unified, and in the same general location, all services may be identified under 6310.

**6399 Other Counseling and Guidance**

**6400 Other Student Services**

Student services administration includes the dean, assistant dean of students and supporting staff engaged in college- or district-wide administration of student personnel activities. Includes transportation services that are involved in taking students to and from the college, but does not include field trips for courses or other specific purposes. Health services encompass those activities and areas such as medical, dental, psychiatric and nurse services for students.

**6420 Disabled Students Programs and Services (DSPS)**

Includes noninstructional activities and services for students with disabilities regardless of the kind of disability, but does not include instructional and service facilities which may have been adapted for the disabled within classrooms, laboratories, offices, libraries, gymnasium, food facilities and logistical support facilities. Use with Program 55 designation.

**6430 Extended Opportunity Programs and Services (EOPS)**

Includes those functions and areas related to the administration and direct services to students within program definition.

**6440 Health Services**

Category includes those health services, activities and areas such as medical, dental, psychiatric and nurse services for students.

**6450 Student Personnel Administration**

Student personnel administration includes the dean or assistant dean of students and supporting staff engaged in college- or district-wide administration of student personnel activities.

**6460 Financial Aid**

Category includes those areas and functions pertaining to the financial and business operation associated with grants, scholarships, transportation and related activities. Exclude those services such as field trips that are for specific courses listed in TOP.

**6470 Job Placement Services**



Includes areas necessary to assist students and employers in job referral, assisting students in development of job finding skills and facilitating on-campus interviews.

**6480 Veterans Services**

Includes facility space necessary to provide services to veterans and their dependents. Example of applicable services include dissemination of information and verification of eligibility standards.

**6491 Student Transportation**

Includes transportation functions that are involved in taking students to and from the college, but does not include field trips for courses or other specific courses.

**6492 Foreign Student Services**

Includes noninstructional activities and services for foreign students that are not provided through other existing on-site facilities, but does not include ethnically distinct environments.

**6499 Other Student Services**

**6500 Maintenance and Operation of Plant**

This function includes all services required for the operation and maintenance of the grounds and facilities for the institution including utilities, building maintenance, grounds maintenance and related custodial services.

**6510 Building Maintenance and Operation Support**

Includes functions for the routine repairs, maintenance and operation of present functioning facilities.

**6530 Custodial Services**

Includes functions designed to provide custodial services to the facilities for use by instructional programs.

**6550 Grounds Maintenance and Repairs**

Includes functions of maintaining both grounds and grounds maintenance equipment.

**6570 Utilities**

Includes functions designed to provide utility support services for the operation of the physical plant.

**6599 Other Maintenance and Operation of Plant**

**6600 Planning and Policy Making**

Category consists of all central executive-level activity concerned with the management and long-range planning of the college and/or district as contrasted to any one program within the college and/or district. Includes executive direction functions, i.e., the governing board, the chief executive officer, superintendent and/or president and the senior executive officers such as assistant superintendents or vice presidents. Also included are those operations devoted to legal services, analytical studies, planning institutional budget and facilities along with other related activities.

**6610 Institutional Research**

Includes the college/district-wide research functions, staffing and administration.

**6620 Management Planning Functions**

Includes the executive management and long-range planning functions, activities and areas for the college and/or district administration. Includes the executive direction given by the superintendent, board and supporting staff officers for the college and/or district.

**6630 Instructional Planning**

Includes the long-range planning function associated with curricular and program development, both at the college and/or district level. This area is more directly related to staff functions than direct administrative management function.

**6699 Other Planning and Policy Making**

**6700 General Institutional Support Services**

Includes all fiscal, administrative, logistical, staff and community relations necessary for the proper functioning of the college.

**6710 Community Relations**

Includes such activities as maintaining relationships with the general community, alumni or other constituents as well as development and fund raising.

**6720 Fiscal Operations**

Includes all budget control, audit, investment, accounting, payroll and management of contracts and grants.

**6730 Human Resources Management**

Includes personnel management activities.

**6750 Staff Development**

Includes activities designed for the professional development of all college staff.

**6760 Staff Diversity**

Includes all areas dedicated to the operation and enhancement of institutional staff diversity.

**6770 Logistical Services**

Includes campus security, fire protection, environmental safety, purchasing, warehouse and stores, the equipment pool and property management, communications services such as reproduction and printing. It also includes specific staff transportation services such as garage and motor pool. When appropriate, this category will include the services of facilities planning at both the college and district levels.

**6780 Management Information Services**

Includes all noninstructional data processing and data management services.

**6791 General Administration Services**

Includes special category, personnel management and maintenance of employee records.

**6799 Other General Institutional Support Services**

**6800 Community Services**

Category includes activities and functions providing general public services or for special groups within the community.

**6810 Community Recreation**

Includes all areas necessary for organizing, promoting and conducting recreation programs.

**6820 Community Service Classes**

Includes instruction that contributes to the physical, mental, moral, economic and/or civic development of individuals or groups enrolled, including contracted community service classes in music, drama, art, handicraft, science, literature, nature study and athletics.

Specifically excludes courses approved by the Chancellor's Office either individually or as part of a credit or noncredit program, which are reported under the applicable Instructional Activity Codes 0100-4900 (TOPS Code).

Includes museums and galleries if Community Service funded.

**6830 Community Use of Facilities**

Includes providing college buildings or grounds for public, literary, scientific, recreational, educational, or public agency meetings, or for the discussion of matters of general or public interest.

**6899 Other Community Services**

**6900 Ancillary Services**

Includes those areas that are other than departmental services, such as food services, parking services, bookstore and related services. Also includes student housing and activities that promote student cultural development but are not included in an actual class such as intramural sports.

**6910 Bookstore**

Includes all functions and services associated with the operation of the bookstore and related activities and areas.

**6920 Child Development Centers**

Includes district-owned or operated child development centers or childcare facilities that may or may not also be used for credit course instruction. All of the assignable square foot areas of the facility which are associated with credit course instruction are to be inventoried as laboratory or demonstration. All other assignable areas of the facility are to be inventoried as childcare.

**6930 Farm Operations**

Includes district-owned or operated farm operations.

**6940 Food Services**

This category includes dining halls, cafeterias, snack bars, restaurants and similar eating areas. It would also include residence halls and faculty clubs. Includes facilities that are open to the student body and/or the public. Areas intended primarily as food facilities but containing vending machines are included in this category. Category also includes such areas as kitchens, refrigeration rooms, freezers, dishwashing rooms, cafeteria serving preparation and cleaning. It may also include such areas in residence halls.

**6950 Parking Services**

Includes all student, staff, and public parking on college property. It also includes parking for evening classes. Public parking for the general public would not be included if not under the control of the college and located on college property. Includes visitors parking.

**6960 Student and Co-curricular Activities**

Includes student activities such as the newspaper, association, intercollegiate athletics and intramural athletics that are not a part of the physical education curriculum. Co-curricular activities and events are an extension of classroom instruction or related community college programs.

**6970 Student Housing (*Dormitories*)**

Student housing activity would include those functions and services that are devoted to the operation of dormitories and actual facilities at the college. Exclude area in a residential facility that may serve some other primary purpose. Classrooms, offices and other office service facilities are illustrative.

**6999 Other Ancillary Services**

**7000 Auxiliary Operations**

Included in this function are the specifically funded activities or programs that are not typically associated with either regular instruction or noninstructional functions described above. Included are programs such as WIN, MDTA, Headstart, EOS, CETA, CWETA, etc. Possible indirect overhead from noninstructional functions which may "support" these programs (general administrative services, logistical services, maintenance and operation of plant, etc.) should not be included here. Also included are activities independent of the mission of the institution such as operation of commercial rental property for income.

**7010 Auxiliary Classes**

Included in this category are specifically funded activities that are not typically associated with regular or noninstructional functions previously described. For example, "Headstart" activity may be considered under the mission of the college, supported, but not part of the college.

Contract education classes that generate FTES or are approved as credit or noncredit by the Chancellor's Office are to be reported under the applicable TOPS code (0100 - 4900).

**7091 Noninstitutional Activity**

Category includes activities and functions independent of the mission of the college. Income property or commercial property for income is illustrative.

**7099 Other Auxiliary Operations**

**7100 Physical Property and Related Acquisitions**

Included in this category are activities required in developing campus physical facilities. The expenditure objects reported for this function are listed under capital outlay.

**7110 Current Operations**

Includes operations and services taking place during the current or fiscal year. Category includes those functions associated with current operations, but limited to building facilities.

**7120 Capital Outlay Projects**

Includes all aspects of building construction. Functions range from site purchases to equipment projects. Projects may be within a fiscal year or planned over a long period of time.

**7199 Other Physical Property and Related Acquisitions**

**9600 Unassigned**

This designation should be used only as a last resort category. All activities are to be assigned to the most appropriate designation possible before use of this designation.

## **REFERENCE SECTION D**

### **Room Use Categories**

## ROOM USE CATEGORIES SUMMARY

<b>000 Room Use</b>		<b>500 Room Use</b>	690 Locker Room
050 Inactive Area		510 Armory	
060 Alteration/Conversion Area	510	515 Armory Service	710 Data Processing/Computer
070 Unfinished Area	520	520 Athletics/Physical Education	715 Data Processing/Computer Service
		523 Athletic Spectator Seating	720 Shop
<b>100 Room Use</b>	525	525 Athletic/Physical Education Service	725 Shop Service
110 Classroom		530 Audio/Visual, Radio, TV	730 Storage
115 Classroom Service	530	535 Audio/Visual, Radio, TV Service	735 Storage Service
	535	540 Clinic Student Care	740 Vehicle Storage Facility
<b>200 Room Use</b>		545 Clinic Service	745 Vehicle Storage Facility Service
210 Class Laboratory	550	550 Demonstration	750 Central Food Storage
215 Class Laboratory Service	555	555 Demonstration Service	760 Central Laundry
220 Special Class Laboratory	560	560 Field Service Building	770 Central Utility Plant
225 Special Class Laboratory Service	570	570 Animal Quarters	
230 Individual Study Laboratory	575	575 Animal Quarters Service	<b>800 Room Use</b>
235 Individual Laboratory Service	580	580 Greenhouse	810 Patient Bedroom
	585	585 Greenhouse Service	820 Patient Bath
250 Non-Class Laboratory	590	Other	830 Nurse Station
255 Non-Class Laboratory Service			840 Surgery
		<b>600 Room Use</b>	850 Treatment
<b>300 Room Use</b>	610	610 Assembly	860 Service Laboratory
310 Office	615	615 Assembly Service	870 Supplies
315 Office Service	620	620 Exhibition	880 Public Waiting
350 Conference Room	625	625 Exhibition Service	895 Health Care Service
355 Conference Room Service	630	630 Food Facilities	
	635	635 Food Facilities Service	<b>900 Room Use</b>
<b>400 Room Use</b>	650	650 Lounge	910 Sleep w/o Toilet/Bath
410 Reading/Study Room	655	655 Lounge Service	919 Toilet/Bath
420 Stack	660	660 Merchandise Facility	920 Sleep/Study w Toilet/Bath
430 Open Stack Reading Room	665	665 Merchandise Facility Service	935 Sleep/Study Service
440 Processing Room	670	670 Recreation	950 Apartment
455 Study Service	675	675 Recreation Service	955 Apartment Service
	680	680 Meeting Room	970 House
	685	685 Meeting Room Service	

# ROOM USE CATEGORIES

## Assignable Areas

### 100 Classroom Facilities (100 - 199)

#### 110 Classroom

Definition: A room used for classes that do not require special purpose equipment for student use.

Description: Included in this category are rooms generally used for scheduled instruction requiring no special equipment and referred to as lecture rooms, lecture-demonstration rooms, seminar rooms and general purpose classrooms. A classroom may be equipped with table armchairs (fixed to the floor, jointed together in groups or flexible in arrangement), tables and chairs (as in a seminar room) or similar types of seating. A classroom may be furnished with special equipment appropriate to the specific area of study if this equipment does not render the room unsuitable for use by classes in other areas of study. These rooms should be inventoried as TOPS classification number 0099, general assignment.

Limitations: This category does not include conference rooms (350), meeting rooms (680), auditoriums (610) or class laboratories (210). Conference rooms and meeting rooms are distinguished from seminar rooms on the basis of primary use. (See categories 350 and 680 for the distinction between conference rooms and meeting rooms.) Auditoriums are distinguished from lecture rooms on the basis of primary use; a class laboratory is distinguished from a classroom on the basis of equipment in the room and by its limited use.

Stations to be reported: Student-stations only. If extra chairs have been placed in a classroom, include only as many of the extra chairs as could normally be included without over-crowding the room.

#### 115 Classroom Service

Definition: A room that directly serves one or more classrooms as an extension of the activities in such a room.

Description: Included in this category are projection rooms, cloak rooms, preparation rooms, closets and storage which serve classrooms. These rooms should be inventoried as classification number 0099, general assignment.

Stations to be reported: **None**

### 200 Laboratory Facilities (200 - 299)

#### 210 Class Laboratory

Definition: A room used primarily by regularly scheduled classes that require special-purpose equipment for student participation, experimentation, observation or practice in a field of study.

Description: A class laboratory is designed for and/or furnished with equipment to serve the needs of a particular discipline for group instruction in regularly scheduled classes. Included in this category are rooms generally referred to as teaching laboratories, instructional shops, typing laboratories, drafting rooms, band rooms, choral rooms, (group) music practice rooms, language laboratories, (group) studios and similar specially designed and/or equipped rooms.



Limitations: This category does not include laboratory rooms that serve as individual study rooms. It does not include laboratories used for group instruction that are informally or irregularly scheduled (220). This category does not include rooms generally referred to as research (non-class) laboratories (250). It does not include gymnasiums, pools, drill halls, laboratory schools, demonstration houses and similar facilities that are included under special use facilities (500). Computer processing facilities used jointly for instruction and/or research and/or administration are coded data processing/computer (710).

Stations to be reported: The number of student stations that the room can physically accommodate at one time.

215 *Class Laboratory Service*

Definition: A room that directly serves one or more class laboratories as an extension of the activities in those rooms.

Description: Included in this category are balance rooms, cold rooms, preparation rooms, stock rooms, dark rooms, equipment issue rooms, greenhouses and similar facilities that serve a class laboratory **only**.

Limitations: This category does not include balance rooms, cold rooms, preparation rooms, stock rooms, dark rooms, etc., that serve special class laboratories (225) or non-class laboratories (255). Rooms that provide housing for laboratory animals are classified as animal quarters (570). Other greenhouses are separately categorized (580) or (560).

Stations to be reported: None

220 *Special Class Laboratory*

Definition: A room used primarily by informally or irregularly scheduled classes or activities that require special-purpose equipment for student participation, experimentation, observation or practice in a field of study.

Description: A special class laboratory may be designed for and/or furnished with equipment to serve the needs of a particular area of study for group instruction in informally or irregularly scheduled classes or activities. Special class laboratories may include such rooms as language laboratories, (group) music practice rooms, (group) studios, etc. **Note that the criteria for differentiating between special class laboratories and class laboratories is the irregular or informal nature of the scheduling, and not the specialization of the equipment or instruction.**

Limitations: This category does not include class laboratories (210), individual music study rooms (230) and research (non-class) laboratories (250). It does not include gymnasiums, pools, drill halls, laboratory schools, teaching clinics, demonstration houses and similar facilities that are included under special use facilities (500). Computer processing facilities used jointly for instruction and/or research and/or administration are coded data processing/computer (710).

Stations to be reported: Student-station. Report the number that could be scheduled at one time.

225 *Special Class Laboratory Service*

Definition: A room that directly serves one or more special class laboratories as an extension of the activities in those rooms.

Description: Included in this category are equipment storage rooms, stock rooms, greenhouses and similar rooms which serve a special class laboratory **only**.

Limitations: This category does not include rooms that serve class laboratories (215), individual music study laboratories (235) or non-class laboratories (255). Rooms that provide housing for laboratory animals are classified as animal quarters (570). Other greenhouses are separate categories (580) or (560).

Stations to be reported: None.

230 *Individual Study Laboratory*

Definition: A room used primarily as an individual study station such as a music practice room.

Description: Included are rooms with individual stations for study activities. Also, included in this category are music (sound proof) rooms of usually less than one hundred square feet where the activity of one to three students is the practice of vocal or instrumental music. The one exception in size may be if the musical instrument involved requires a larger space.

Stations to be reported: Student stations only.

235 *Individual Study Laboratory Service*

Definition: Rooms that serve directly the individual study rooms of category 230.

Stations to be reported: None

250 *Non-Class Laboratory*

Definition: A room used for laboratory applications, **research**, and/or training in **research methodologies that require** special-purpose equipment for staff and/or student experimentation or observation.

Description: Included in this category are rooms generally referred to as research laboratories and research laboratory-offices.

Limitations: This category does not include rooms referred to as teaching laboratories, such as class laboratories (210), special class laboratories (220) or individual study laboratories (230).

Stations to be reported: Staff-stations in terms of the number of faculty members and/or equivalent nonfaculty professional research staff that the room accommodates.

255 *Non-Class Laboratory Service*

Definition: A room that directly serves one or more non-class laboratories as an extension of the activities in those rooms.

Description: Included in this category are balance rooms, cold rooms, stock rooms, dark rooms, etc., that serve a non-class laboratory, except animal rooms and greenhouses.

Limitations: This category does not include balance rooms, cold rooms, stock rooms, dark rooms, etc., that serve a class laboratory (215), a special class laboratory (225) or an individual study laboratory (235). Rooms that provide housing for laboratory animals are classified as animal quarters (570). Greenhouses are separately categorized (580).

Stations to be reported: None

**300 Office Facilities (300 - 399)**

310 *Office*

Definition: A room used by faculty, staff or student officers working at a desk (or table).

Description: An office is typically equipped with one or more desks, chairs, tables, bookcases and/or filing cabinets. Included in this category are rooms generally referred to as faculty offices, administrative offices, clerical offices, graduate assistant offices, teaching assistant offices, student offices or space assigned to an individual as office. Included in this category is a studio (music, art, etc.) if that room also serves as the office of a staff member.

Limitations: Special note should be taken of rooms that are equipped both as office and "research laboratory". A room equipped with laboratory benches, specialized scientific equipment and/or such utilities as gas, water, steam, air, etc. is classified as a non-class laboratory (250). Note that this distinction rests on equipment rather than function. It is recommended that those rooms that have office-type equipment and fixed laboratory-type equipment (primarily in the biological and physical sciences) within the same room be classified as non-class laboratories (250). **Large rooms**, such as glass shops, printing shops, reading rooms, library processing rooms (440), etc., that incidentally contain desk space for a technician or staff member are classified according to the primary purpose of the room, rather than as offices.

Stations to be reported: Staff-stations in terms of the number of faculty members and/or nonfaculty staff that the room accommodates. Exclude visitor seating.

315 *Office Service*

Definition: A room that directly serves an office or group of offices as an extension of the activities in those rooms.

Description: Included in this category are file rooms, mimeograph rooms, vaults, waiting rooms, interview rooms, closets, private toilets, records rooms, office supply rooms, PBX switchboards and internal corridors within office suites.

Limitations: Centralized mimeograph and printing shops that are campus-wide should be classified as shop facilities (720).

Stations to be reported: None

350 *Conference Room (Office Related)*

Definitions: A room serving offices and used primarily for staff meetings and departmental activities other than instructional.

Description: A conference room may be equipped with tables and chairs, lounge-type furniture, straight-backed chairs and/or tablet arm chairs. Normally it is used by a specific organizational unit, in contrast to meeting rooms (680) which are used for general purposes such as community group meetings. It is distinguished from facilities such as seminar rooms, lecture rooms and general classrooms (110) because it is used primarily for activities other than scheduled classes. **Rooms that serve both as conference rooms and meeting rooms should be classified according to their principal use.**

Limitations: This category does not include classrooms (110), seminar rooms (110), lecture rooms (110), auditoriums (610) or lounge facilities (650).

Stations to be reported: The total number of seats, including chairs not directly at the table if all chairs constitute a reasonable complement of furniture for the usual uses of the room. An example is conference rooms in which it is not essential that every person attending a conference be seated at the table.

**Note:** In the case of a conference room that is significantly under- or over-supplied with chairs, i.e., to the extent that the room is either over-crowded or could accommodate considerably more chairs, the number of stations should be reported in terms of a reasonable layout of furniture. Avoid distorting tabulated data resulting from a condition which may be remedied on days other than the day of a utilization survey.

355 *Conference Room Service (Office Related)*

Definition: A room that directly serves one or more conference rooms as an extension of the activities in those rooms.

Description: Included in this category are such rooms as kitchenettes, chair storage rooms, projection rooms, sound equipment rooms, etc.

Limitations: This category does not include kitchens, chair storage and similar facilities that serve meeting rooms (680) and (685) service.

Stations to be reported: None

**400 Study Facilities (400 - 499)**

410 *Reading/Study Room*

Definition: A room used by individuals to study books or audio/visual materials.

Description: Included in this category are rooms generally referred to as library reading rooms, carrels, study rooms, individual study stations, study booths and similar rooms that are intended for general study and tutoring purposes. Study stations may be grouped (as in a library reading room) or individualized (as in a carrel). Study stations in a reading room may include typewriters, remote terminals of a computer, electronic display equipment, etc. (See also 430.) Reading rooms may be located not only in libraries but also in residence halls or academic buildings.

Limitations: This category does not include classrooms (110), class laboratories (210), special class laboratories (220), individual study laboratories (230), non-class laboratories (250), offices (310), sleep/study rooms in residence halls or other housing units (910 or 920), waiting rooms (315) or lounge facilities (650).

Stations to be reported: The total number of all types of study-stations in the room.

**Note:** In special facilities for blind or other persons with disabilities, the number of stations should be reported in terms of persons with disabilities only - excluding, for example, the chair for the blind student's reader.

420 *Stack*

Definition: A room (or portion of a room) used to provide shelving for library or audio/visual materials.

Description: Included in this category are rooms generally referred to as library stacks. (See 430.)

Limitations: This category does not include bookshelf space in classrooms, laboratories or offices. Audio/visual film and tape libraries that generally serve groups (rather than individuals) are classified as audio/visual, radio, TV facilities (530).

Separate tape storage rooms for language laboratories should be classified as special class laboratory service (225) or individual study laboratory service (235). Separate rooms containing musical scores, records and tapes are classified as stack space if the primary purpose of the materials is for instruction or research (as in a library or music building). Rooms containing such materials and intended for listening enjoyment (as in a student union) should be classified as recreation facility service (675).

Stations to be reported: The number of carrels or other individual study-stations within the stack area.

**Note:** Tables, shelves or other work-surfaces for use in the process of browsing and selecting reference material are **not** carrels or study-stations and should **not** be counted as stations.

430 *Open Stack Reading Room*

Definition: A room that is a combination of a reading room and stack, generally without physical boundaries between the stack and reading room areas.

Description: Included in this category are rooms generally referred to as open stack reading rooms.

Limitations: This category is not used if the area of an open stack reading room can be prorated to reading room (410) and stack (420) at the time the physical inventory is made. This category might be used as "working-purposes" category if proration on some appropriate basis is anticipated. Further limitations are defined under reading room (410) and stack (420).

Stations to be reported: The total number of all types of study-stations in the room.

440 *Processing Room*

Definition: A room which serves a reading/study room, stack or open stack reading room as a supporting service to such rooms.

Description: Included in this category are areas generally used to house card catalogs, circulation desks, cataloging space, bookbinding, microfilm processing and audio/visual record-playback equipment for distribution to study stations.

Limitations: This category does not include such library space as offices for staff (310), instructional facilities for library science students that are to be classified as classrooms (110), class laboratories (210), special class laboratories (220), offices (310) or other appropriate designations. (See AV 530 - 535.)

Stations to be reported: The total number of all types of work stations in the room.

455 *Study Service*

Definition: A room which directly serves reading/study rooms, stacks, open stack reading rooms or processing rooms as a direct extension of the activities in those rooms.

Description: Other categories in these divisions have provided a "service" category for each type of room. Because such facilities are minimal in library-type spaces, this category of study facility service space is

provided for all types of study facilities. Included are such areas as rooms in which study materials are stored (closets, locker space, coatrooms, etc.).

Limitations: This category does not include card catalogs, circulation desks and other areas designated as processing rooms (440).

Stations to be reported: None

## 500 Special Use Facilities

### 510 *Armory*

Definition: A room or area used by Reserve Officer Training Corps (ROTC) units.

Description: This category includes indoor drill areas, indoor rifle ranges and special-purpose military science rooms.

Limitations: Classrooms (110), class laboratories (210) and offices (310) in an armory facility are designated as such, even though they are located in an armory building.

Stations to be reported: None.

### 515 *Armory Service*

Definition: A room that directly serves an armory facility as an extension of the activities of that facility. Gun storage rooms for campus security personnel are to be included in this category.

Description: This category includes supply rooms, weapons rooms, coatrooms, etc.

Limitations: Classroom service rooms (115), class laboratory service rooms (215) and office service rooms (315) are so classified even though they are located in an armory building.

Stations to be reported: None.

### 520 *Athletic/Physical Education*

Definition: A room (or area) used by students, staff or the public for athletic/physical education activities.

Description: Included in this category are rooms generally referred to as gymnasiums, basketball courts, handball courts, squash courts, wrestling rooms, indoor swimming pools, indoor ice rinks, indoor tracks, indoor "fields", fieldhouses, weight-lifting and multi-purpose PE rooms.

Limitations: No distinction by room use category is made on the basis of instructional versus intramural or intercollegiate use of gymnasiums, swimming pools, etc. The program dimension of this classification structure provides the capability of making those distinctions.

Institutions that wish to study the utilization of such facilities will need to further subdivide this category. This category does not include classroom facilities (100), laboratory facilities (200), or office facilities (300), even though they may be located in an athletic building. This category does not include the spectator seating area associated with athletic facilities (523). It does not include outside fields, tennis courts, archery ranges, etc. This category does not include rooms used for recreational purposes (670) such as bowling alleys, billiard rooms, ping pong rooms, ballrooms, chess rooms, card playing rooms or hobby rooms.

Stations to be reported: None.

523 *Athletic Facilities Spectator Seating*

Definition: The seating area used by students, staff or the public to watch athletic events.

Description: Included in this category are permanent seating areas in fieldhouses, gymnasiums and natatoria.

Limitations: This category does not include temporary seating areas in fieldhouses, gymnasiums and natatoria.

Stations to be reported: The designed or normal capacity of the seating area.

525 *Athletic/Physical Education Service*

Definition: A room that directly serves an athletic/physical education facility as an extension of the activities in that facility.

Description: Included in this category are rooms generally referred to as physical education locker rooms, toilet rooms, shower rooms, coaches' rooms, ticket booths, dressing rooms, equipment supply rooms, first aid rooms, skate sharpening rooms, towel rooms and storage rooms for PE equipment, etc.

Limitations: This category does not include public toilet rooms.

Stations to be reported: None.

530 *Audio/Visual, Radio, TV*

Definition: A room or group of rooms used for the production and distribution of audio/visual, radio and TV materials, and for the operation of equipment for the transmission of these materials.

Description: This category includes rooms generally referred to as TV studios, radio studios, sound studios, graphics studios and similar rooms.

Limitation: Studios used primarily as part of an instructional program to train students in communication techniques should be classified as class laboratories (210) or as special class laboratories (220). Projection booths adjacent to instructional space are classified as service areas.

**Note:** This category is intended to be used only for facilities whose primary purpose is to disseminate instructional materials and activities. It is **not** to be used for facilities which are part of the instructional laboratories of a department of theater, television or dramatic arts, nor is it to be used for those spaces in which AV materials are used by students in their pursuit of course work.

535 *Audio/Visual, Radio, TV Service*

Definition: A room that directly services an audio/visual, radio or TV facility as an extension of the activities in that facility.

Description: Included in this category are rooms generally referred to as film libraries, tape libraries, control rooms, videotape recorder rooms, property storage, recording rooms, engineering maintenance rooms, darkrooms, preparation rooms, and equipment servicing and storage rooms.

Limitations: Control rooms, recording rooms and similar facilities used primarily to train students in communication techniques should be classified as class laboratory service (215) or special class laboratory service (225).

Stations to be reported: None.

540 *Clinic Student Care (Nonhealth Professions)*

Definition: A room used only for the diagnosis of clients (students) in a program other than medicine (human or veterinary), dentistry and student health care.

Description: Included in this category are closed rooms generally referred to as client examining rooms. Clinics for nonhealth purposes are typically associated with such educational disciplines as psychology, speech, hearing, reading (remedial) and writing (remedial).

Limitations: This category does **not** include facilities for remedial, prescriptive or therapeutic instruction for individuals, groups or classes of students or facilities associated with student health care, medical or dental treatment of humans or animals.

Stations to be reported: None.

545 *Clinic Service (Nonhealth Professions)*

Definition: A room that directly services the clinic room(s).

Description: Included in this category are waiting room(s), control rooms, records room(s).

Limitations: This category does not include rooms that serve as remedial, prescriptive or therapeutic instruction or counseling either for individuals, groups or classes.

Stations to be reported: None.

550 *Demonstration*

Definition: A room (or group of rooms) used to practice the principles of certain disciplines such as teaching, home economics and child development.

Description: This category includes demonstration schools, laboratory schools, preschool nurseries, child development facilities, etc., if the facilities support the training of college-level students as teachers. This category includes home management houses that serve to train college-level students in home economics and preschool education.

Limitations: Demonstration schools, laboratory schools, preschool nurseries and home management houses in which the students serve as the subjects are classified as non-class laboratories (250). However, classrooms (110) or class laboratories (210) in such facilities used primarily for college-level student instruction should be so classified. Childcare facilities that are district ancillary services are excluded in this category and included as a merchandising facility (660).

Stations to be reported: None.

555 *Demonstration Service*



Definition: A room that directly serves a demonstration facility as an extension of the activities in that facility.

Description: Included in this category are facilities generally referred to as storerooms, laundry, etc., in a home demonstration facility, and as kitchen, lockers, toilet rooms, shower rooms, etc., in a laboratory school.

Limitations: In general, the primary activity areas such as kitchen, dining room, living room (in a home demonstration house), or classrooms, laboratories, gymnasiums that serve nursery, elementary, or secondary school students (in a laboratory school) should be designated as demonstration facilities.

Stations to be reported: None.

560 *Field Service Facility*

Definition: A barn or similar structure for animal shelter or the handling, storage and/or protection of farm products, supplies, and tools, and for field experiments.

Description: Field-service facilities include barns, animal shelters, sheds, silos, feed units, hay storage and seedhouses. Greenhouses related to farm operations are included in this category. Structures are typically of light frame construction with unfinished interiors, usually but not exclusively related to agricultural field operations, and are frequently located outside the central campus area. Also included are such facilities as meteorological field test stations.

Limitations: Location of a building off-campus is not sufficient justification for classification as a field-service facility.

Stations to be reported: None.

570 *Animal Quarters*

Definition: A room that houses laboratory animals maintained for the institution for research and/or instruction purposes.

Description: This category includes rooms generally referred to as animal rooms, cage rooms, stalls, wards and similar rooms that are used to house animals intended for use in class laboratories, non-class laboratories, special class laboratories or individual study laboratories.

Limitations: Does not include areas for treatment of patient animals. See teaching labs (210).

Stations to be reported: None.

575 *Animal Quarters Service*

Definition: A room that directly serves an animal care facility as an extension of the activities in that facility.

Description: The category includes rooms generally referred to as feed storage rooms, feed mixing rooms, cage washing rooms and similar facilities such as surgery, casting or instrument rooms.

Limitations: Does not include areas that directly serve areas used for the treatment of patient animals. See teaching lab services (215).

Stations to be reported. **None.**

580 *Greenhouse*

Definition: A building or room, usually composed of glass or other light transmitting materials, for the cultivation and/or protection of plants.

Description: Includes rooms generally referred to as greenhouses.

Limitations: Does not include greenhouses related to farm operations. (See 560.) If the greenhouse serves as a teaching lab for instructional purposes, the classification is (210), (220) or (230) and will report student stations. If a greenhouse serves as laboratory services it is (215), (225) or (235).

Stations to be reported: None.

585 *Greenhouse Service*

Definition: A room that directly serves a greenhouse facility as an extension of the activities of that facility.

Description: Includes rooms generally referred to as headhouses.

Limitations: Does not include greenhouses related to farm operations. (See 560.)

Stations to be reported: None.

590 *Other*

Definition: A category of last resort.

Description: This category is included only to account for and classify those support facilities that cannot be described, even approximately, with available codes and definitions.

Limitations: This category should have extremely limited use.

Stations to be reported: None.

**600 General Use Facilities (600 - 699)**

610 *Assembly*

Definition: A room designated and equipped for the assembly of large numbers of persons for such events as dramatic, musical, devotional, livestock judging or commencement activities.

Description: This category includes rooms generally referred to as theaters, auditoriums, concert halls, arenas, chapels and livestock judging pavilions. Seating area, stage, orchestra pit, chancel, arena and aisles are included in assembly facilities. Assembly facilities may also service instructional purposes to a minor or incidental extent.

Limitations: Assembly facilities that are used primarily for instructional purposes are classified as classrooms (110).

Stations to be reported: The area bounded by the side and rear walls of the audience seating area, and by the plane of the proscenium arch, should be reported as a separate room (or rooms if there is a balcony); and the **audience seating capacity** of that area is to be reported as the number of stations.

615 *Assembly Service*

Definition: A room that directly serves an assembly facility as an extension of the activities of that facility.

Description: This category includes check rooms, coat rooms, ticket booths, dressing rooms, projection booths, property storage, makeup rooms, costume storage, green rooms, control rooms, scene shops, etc.

Limitations: Lobbies are non-assignable space.

Stations to be reported: None.

620 *Exhibition*

Definition: A room used for exhibition of materials, works of art, artifacts, etc., and intended for general use by students and the public.

Description: This category includes museums, art galleries and similar exhibition areas.

Limitations: Collections not primarily for general exhibition, such as departmental displays of anthropological, botanical or geological specimens, should be classified under an appropriate laboratory category.

Stations to be reported: None.

625 *Exhibition Service*

Definition: A room that directly serves an exhibition facility as an extension of the activities in that facility.

Description: This category includes work rooms for the preparation of materials and displays, vaults or other storage for works of art, check rooms, etc.

Limitations: Research areas in museums are classified as non-class laboratories (250) or non-class laboratory service (255).

Stations to be reported: None.

630 *Food Facilities*

Definition: A room used for eating food.

Description: This category includes dining halls, cafeterias, snack bars, restaurants and similar eating areas, including such areas as residence halls, faculty clubs, etc. This category includes facilities that are open to the student body and/or the public. Areas intended primarily as food facilities, even though containing vending machines rather than serving counters, are included in this category. Rooms with vending machines other than for regular meal or snack service are classified as lounge facilities (650) or merchandising facilities (660).

635 *Food Facilities Service*

Definition: A room that directly serves a food facility as an extension of the activities in that facility.

Description: This category includes such areas as kitchens, refrigeration rooms, food storage, freezers, dishwashing rooms, cafeteria serving, preparation, cleaning, etc., including such areas in residence halls.

Stations to be reported: None.

650 *Lounge*

Definition: A room used for rest and relaxation.

Description: A lounge facility is typically equipped with upholstered furniture, draperies, and/or carpeting, and may include vending machines.

Limitations: A lounge facility is distinguished from a conference room (350) and a meeting room (680) by an informal atmosphere and its general public availability. A lounge area associated with a toilet is non-assignable space. A room devoted wholly to vending machines is classified as a merchandising facility (660). Vending machine areas in food facilities are classified as 630.

Stations to be reported: None.

655 *Lounge Service*

Definition: A room that directly serves a lounge facility, such as kitchenette.

Stations to be reported: None.

660 *Merchandising Facility*

Definition: A room (or group of rooms) used to sell products or services.

Description: This category includes such rooms as bookstores, barber shops, post offices, dairy stores, florist shops and vending machine areas devoted wholly to vending machines. It includes noncredit course childcare facilities, real estate operations, public hostelrys and all other noncredit course vending operation facilities other than staff and student housing (900).

Limitations: This category does not include dining rooms, restaurants, snack bars and similar food facilities (630) or vending machine areas associated with food facilities or lounges (650) for student and staff use. Student and staff hotel and motel rooms are classified in the appropriate category of residential facilities.

Stations to be reported: None.

665 *Merchandising Facility Service*

Definition: A room that directly serves a merchandising facility as an extension of the activities in that facility.

Description: Included in this category are rooms generally referred to as supply closets, sorting rooms, freezers, telephone rooms and private toilets.

Stations to be reported: None.

670 *Recreation*

Definition: A room used by students, staff and/or the public for recreational purposes.

Description: This category includes such rooms as bowling alleys, pool and billiard rooms, ping pong rooms, ballrooms, chess rooms, card-playing rooms, (noninstructional) music listening rooms and hobby rooms.

Limitations: This category does not include gymnasiums, basketball courts, handball courts, squash courts, wrestling rooms, swimming pools, ice rinks, indoor tracks, indoor "fields" or fieldhouses that should be classified as athletic/physical education facilities (520). It does not include outdoor facilities such as tennis courts, archery ranges, fields (football, hockey, etc.), or golf courses.

Stations to be reported: None.

675 *Recreation Service*

Definition: A room that directly serves a recreation facility as an extension of the activities in that facility.

Description: This category includes storage closets, equipment issue rooms, cashiers' desks and similar rooms.

Limitations: This category does not include kitchens, short-order kitchens, snack bars or other food facilities. It does not include athletic/physical education facility service (525) such as locker rooms, shower rooms, ticket booths, dressing rooms and other similar service areas.

Stations to be reported: None.

680 *Meeting Room*

Definition: A room primarily used for a variety of non-class meetings.

Description: A meeting room may be equipped with tables and chairs, lounge-type furniture, straight-back chairs and/or tablet arm chairs. Although it may be assigned to a specific organizational unit, it is used primarily by groups for general purposes such as student senate, student government, community groups, identified student groups and short-term meetings conducted by a community service division. The public could normally make use of these rooms, usually on an invited basis.

Limitations: Rooms serving offices and used primarily for staff meetings are classified as conference rooms (350). Seminar rooms used primarily for scheduled classes are classified as classrooms (110).

Stations to be reported: The normal seating capacity for the room size.

685 *Meeting Room Service*

Definition: A room that serves a meeting room as an extension of the activities of that room.

Description: Included in this category are such rooms as kitchenettes, chair storage rooms, projection rooms, sound equipment rooms, etc.

Limitations: This category does not include such rooms as kitchenettes and chair storage rooms that serve conference rooms (350).

Stations to be reported: None.

690 *Locker Room*

Definition: A room available on general assignment used for storing personal materials.

Description: Includes service rooms intended for student and/or staff use principally for storage of clothing and/or individual materials.

Limitations: Locker rooms associated with disciplines and used for special assignment should be classified as service to their respective disciplines.

Stations to be reported: None.

## **700 Supporting Facilities (700-799)**

### **710 *Data Processing/Computer***

Definition: A room or groups of rooms used for processing of data by computers.

Description: This category includes keypunch rooms, electronic data processing rooms, electronic computer rooms and similar data processing areas.

Limitations: This category does not include rooms containing desk calculators, post-billing machines, check-writing machines and similar office or office service rooms. A data processing facility used only for instruction should be classified as a class laboratory (210), special class laboratory (220) or individual study laboratory (230).

Stations to be reported: None.

### **715 *Data Processing/Computer Service***

Definition: A room that directly serves a data processing computer facility as an extension of the activities in that facility.

Description: This category includes such rooms as card storage, paper form storage, tape storage, control rooms, plugboard storage, wiring rooms, equipment repair rooms, observation rooms and similar service areas.

Limitations: This category does not include rooms for data processing personnel. These rooms should be classified as office (310).

Stations to be reported: None.

### **720 *Shop***

Definition: A room used for the manufacture, repair or maintenance of products or equipment.

Description: This category includes such rooms as carpenter shops, plumbing shops, electrical shops, painting shops, auto shop and similar physical plant maintenance facilities. It also includes central printing and duplicating shops.

Limitations: This category does not include instructional shops; industrial arts and vocational-technical shops used for instruction should be classified as class laboratories (210). Materials preparation areas in audio/visual, radio stations and TV studios should be appropriately classified (535). Engineering drafting rooms serving the physical plant operations are classified as offices (310). Blueprint storage rooms are classified as office service (315).

Stations to be reported: None.

725 *Shop Service*

Definition: A room that directly serves a shop facility as an extension of the activities in that facility.

Description: Included in this category are tool supply-storage rooms, materials storage rooms and similar equipment or material supply and/or storage rooms. Locker rooms, shower rooms, lunchrooms and similar nonpublic areas that service the shop facility should be included.

Limitations: This category does not include service areas related to class laboratories (215) or non-class laboratories (255).

Stations to be reported: None.

730 *Storage*

Definition: A room used to store materials.

Description and Limitations: Classification of a room as a storage facility is limited by definition to a central storage facility (warehouse). Storage related to other types of space follow the classification of that type of space with a "service" designation. For example, a storage closet for office supplies is classified as office service (315). The distinction between the "service" and "storage" classifications rests on the physical separation of the materials stored. If the materials being stored could be placed in a warehouse implying only occasional demand for the materials, then "storage facility" is the appropriate classification. Materials that are stored close at hand because of the nature of the materials and/or program demands should be classified in the appropriate "service" category.

Stations to be reported: None.

735 *Storage Service*

Definition: A room that directly serves a storage facility.

740 *Vehicle Storage Facility*

Definition: A room or structure that is used to house and/or store vehicles.

Description: This category includes parking structures and other rooms and buildings generally referred to as garages, boat houses, airport hangars and other storage areas for vehicles (broadly defined).

Limitations: This category does not include portions of barns or similar field building facilities that are used to house farm implements. Uncovered exterior parking areas are excluded.

Stations to be reported: None.

745 *Vehicle Storage Facility Service*

Definition: A room or structure used to service vehicle storage areas.

Description: This category includes any area associated with a vehicle storage facility.

Limitations: This category does not include service areas that serve building maintenance and repair. Those are classified as shop facilities (720).

Stations to be reported: None.

750 *Central Food Storage*

Definition: A central facility for the processing and storage of foods used in food facilities.

Description: This category includes food storage areas, lockers, cold rooms, refrigerators, meat processing areas and similar facilities located in a **central** food stores building.

Limitations: Offices (310) located in a **central** food stores building are so classified. Food storage areas, freezers, lockers, etc. not located in a **central** food stores building are classified as food facility service (635).

Stations to be reported: None.

760 *Central Laundry*

Definition: A central facility used for cleaning, washing, drying and ironing linens, uniforms, etc.

Description: This category includes laundry rooms, drying rooms, ironing rooms, etc., located in a central laundry.

Limitations: Offices (310) located in a central laundry are so classified. Laundry rooms, drying rooms, ironing rooms, etc., not located in a central laundry are classified as residential facilities or as service space to the type of facility they serve.

Stations to be reported: None.

770 *Central Utility Plant*

Definition: A facility that provides heating, cooling, centralized security systems equipment and controls space in a **centralized** location.

Description: This category includes boiler, pump, chilling rooms and electric control rooms. Fire alarm and intrusion systems may be centrally located in the facility.

Limitations: Offices (310) located in a central utility plant are so classified.

Stations to be reported: None.

**800 Health Care Facilities (800 - 899)**

**Note:** This category includes the room uses listed below that are located in student health facilities and in health professions clinics and in hospitals. The codes and definitions in this series (800) are designed to describe health care facilities for humans as well as animals requiring health care. This category does **not** include nonmedical clinic facilities. Offices that serve in health care activities are classified as offices (310).

810 *Patient Bedroom*

Definition: A room equipped with a bed and used for patient care.



Description: This category includes general nursing care, acute care, semi-convalescent/rehabilitative adult or pediatric bedrooms, intensive care units, progressive coronary care units, emergency bed care units, observation units, infant care nurseries, incubator units, wards, etc. Connected clothes closets are included.

Stations to be reported: Based on designed capacity.

820 *Patient Bath*

Definition: A room containing patient bath and toilet facilities.

Description: Included in this category are toilet/bath facilities adjoining or in conjunction with patient bedrooms.

Limitations: Public toilet facilities are excluded.

Stations to be reported: None.

830 *Nurse Station*

Definition: A room or area used by nurses who are supervising and/or administering health care facilities.

Description: Included in this category are areas devoted to records charting, reception desks, admission desks and areas adjoining nurses stations, such as utility rooms, work-storage areas, formula preparation areas, medications areas, etc.

Limitations: Rooms that can be identified as offices should be classified 310.

Stations to be reported: Based on designed capacity.

840 *Surgery*

Definition: A room used for surgery.

Description: Included in this category are major and minor surgery rooms, delivery rooms, special procedures, operating rooms and rooms used in conjunction with and as a direct extension of the activities of a surgery room. Included are labor rooms, recovery rooms, monitoring/observation rooms, special support equipment rooms (e.g., anesthesia, heart, lung, x-ray, etc.), dictation booths, scrub-up areas, instrument clean up and storage, gurney storage, sterile supplies storage.

Stations to be reported: None.

850 *Treatment*

Definition: A room used for diagnostic and therapeutic treatment.

Description: Included are rooms used for radiology, fluoroscopy, angiography, physical therapy, dialysis, cardiac catheterization, pulmonary function/vascular testing, EEG, ECG, EMG. Also included are combined doctor's office and examination/treatment rooms and rooms which support treatment rooms as a direct extension of the activities of such a facility including dressing rooms, film processing and viewing rooms, work preparation rooms, special equipment storage.

Stations to be reported: That number which can be treated at one time.

860 *Service Laboratory*

Definition: A room used to provide diagnostic support services to health care facilities.

Description: Includes rooms generally referred to as pathology labs, pharmacy labs, autopsy labs, labs for hematology, chemistry tissue, bacteriology, serology, blood bank, basal metabolism, isotope. Also rooms which serve service laboratories as a direct extension of the activities of such a facility, such as rooms generally referred to as cadaver storage/morgue, autoclave and centrifuge rooms, warm and cold rooms.

Limitations: This category does not include class laboratories (210), special class laboratories (220) or other facilities used primarily for organized instruction.

Stations to be reported: None.

870 *Supplies*

Definition: A room used to store supplies for health care facilities.

Description: Central supply, pharmacy supplies/storage and dispensary, miscellaneous storage of a relatively inactive nature, other than that included in other primary and service room types.

Stations to be reported: None.

880 *Public Waiting*

Definition: A room used by the public to await admission, treatment or information.

Description: Included are lobbies, waiting and reception areas, visiting areas and viewing areas.

Limitations: Lounges (650) and office waiting rooms (315) are excluded from this category.

Stations to be reported: The normal seating capacity of each room.

895 *Health Care Service*

Definition: Rooms used for housekeeping, linen storage and handling. Includes rooms used by housekeeping staff for storerooms, closets, locker rooms, etc., for building maintenance and operation.

Limitations: Non-assignable areas are explicitly excluded from this category. Excludes mechanical and equipment areas.

Stations to be reported: None.

**900 Residential Facilities (900 - 999)**

**Note:** Offices that serve residential activities are coded 310. Likewise, food facilities that serve student and faculty housing activities are coded 630 and 635.

910 *Sleep/Study without Toilet/Bath*

Definition: One or more residential rooms for one or more individual(s) typically furnished with bed(s), wardrobe(s), desk(s) and chair(s) without an internally connected bath.

Description: This category includes single or multiple sleep/study rooms. A sleep/study facility may be a room for combined sleep/study, a room exclusively for sleeping or a room for living/study and includes connected closets.

Limitations: Study rooms for general use, available and open to the dormitory residents at large, and not part of bedroom or sleeping room suites, should be classified as reading/study (410). Residential quarters equipped with cooking facilities are coded as apartment (950). Separate food preparation rooms serving sleep/study areas, including small kitchens used by the occupants, are coded as food service (635).

Stations to be reported: Only if the residential rooms are designed and furnished for one or more individuals.

919 *Toilet/Bath*

Definition: A toilet and/or bathroom intended to be used only by the occupants of the residential facilities rather than by the general public.

Description: This category includes **common** or **shared** bathroom facilities which may consist of full or half-baths, showers, or toilet and shower combinations, used by the residents, and accessible from a corridor or other general circulation area.

Limitations: This category does not include **public** rest rooms. Bathrooms internal to a sleep/study room (920), apartment (950) or house (970) are included in those respective categories.

Stations to be reported: None.

920 *Sleep/Study with Toilet/Bath*

Definition: This category includes single or multiple sleep/study rooms with bath facilities internal to the suite and not separately coded 919. A sleep/study facility may be a room for combined sleep/study, a room exclusively for sleeping or a room for living/study. Connected closets are included.

Limitations: Study rooms for general use, available and open to the dormitory residents at large, and not part of bedroom or sleeping room suites, should be classified as reading/study (410). Residential quarters equipped with cooking facilities are coded as apartment (950). Separate food preparation rooms serving sleep/study areas, including small kitchens used by the occupants, are coded as food facilities service (635).

Stations to be reported: Only as to design for single or multiple use.

935 *Sleep/Study Service*

Definition: A room (or group of rooms) which directly serve the occupants of an individual sleep/study room with or without toilet/bath (see 910 and 920).

Description: This category includes mail rooms, laundry and pressing rooms, linen closets, maid rooms, serving rooms, trunk storage rooms and telephone rooms which serve the occupants of sleep/study facilities.

Limitations: This category does not include food facilities (630 and 635), central laundry (760), or central food stores (750), toilet/bath (916), lounge facilities (650), recreation or activity areas (670, 675), or non-assignable building service areas.

Stations to be reported: None.

950 *Apartment*

Definition: A complete living unit that is not a separate structure.

Description: This is the basic module or group of rooms designed as a complete housekeeping unit, i.e., contains bedroom(s), living room(s), kitchen and toilet facilities. It is not intended that individual rooms be specifically identified within the apartment, but only that the total interior space be reported. This category includes apartments provided for faculty, staff or students. Apartments need not be located in a residential building.

Stations to be reported: Only to rated capacity.

955 *Apartment Service*

Definition: A room or area that directly serves an apartment or group of apartments as an extension of the activities in that facility.

Description: This category includes laundry rooms, mailrooms, linen closets, maid rooms, trunk storage rooms and telephone rooms that serve apartment facilities.

Stations to be reported: None.

970 *House*

Definition: A complete living unit that is a separate structure.

Description: This is the basic module or group of rooms designed as a complete housekeeping unit, i.e., contains bedroom(s), living room(s), kitchen and toilet facilities. It is not intended that individual rooms be specifically identified within the structure, but only that the total interior area reported. This category includes houses provided for faculty, staff or students.

Stations to be reported: Only if assigned a given capacity.

**000 Facilities Out of Service** (*No stations to be reported*)

050 *Inactive Area*

Definition: Rooms that are available for assignment to an organizational unit or activity but are unassigned at the time of the inventory.

Limitations: Rooms that are being modified or are not completed at the time of the inventory are classified as 060 or 070.

060 *Alteration or Conversion Area*

Definition: Rooms that are temporarily out of use because they are being altered, remodeled or rehabilitated at the time of the inventory.

Limitations: Rooms that are inactive or are not completed at the time of the inventory are classified 050 or 070, respectively.

070 *Unfinished Area*

Definition: All potentially assignable areas that are not completely finished at the time of the inventory.

Limitations: This category is intended only for the unfinished part of a building or addition. The parts that are in use should be classified elsewhere.

**Circulation, Access, Custodial, Mechanical and Structural Areas.**

These are spaces within a facility/building which can be readily identified but which are not to be included or used in the statewide *Space Inventory* as assignable feet. See **Reference Section B**, *Classification of Building Areas* for detailed **circulation, custodial** and **mechanical area** descriptions.

## **REFERENCE SECTION E**

### **Suggested Standard Patterns for Room Numbering**

## **SUGGESTED STANDARD PATTERNS FOR ROOM NUMBERING**

This reference section suggests standard patterns for the numbering of rooms in buildings of five basic shapes. Patterns for particular buildings can be developed as variations of these standard patterns, adhering to the following principles:

If you are only adding a new room to an existing building FUSION will prompt you with a new number which may be overridden if it is inappropriate for use with the new room.

### **Purpose**

*Uniformity.* A standard pattern of room numbers allows for all possible room number sequences. If applied at the time working drawings for the building are **approved**, a standard pattern eliminates confusion which results when final room numbers are based on a system of consecutive numbers commonly used on architectural plans.

*Flexibility.* Again, a standard pattern of room numbers permits the assignment of new room numbers in logical relationship to existing room numbers, when new rooms are created by the addition and removal of partitions.

*Convenience.* Assignment of room numbers on all floors of a building according to a single basic pattern enables users of the building to find rooms with the least possible difficulty. Permanence of the room numbers also simplifies record keeping.

# DEVELOPMENT OF A PATTERN

## Horizontal Progression

*Starting Point.* Preferably at or near the principal entrance, and at an end or corner of the building. (If both conditions cannot be met, the choice must be based on judgement as to which starting point will permit the simpler and more logical progression.)

*Direction of Progression.* The direction of heaviest flow of traffic entering the building.

*Even and Odd Numbers.* Assign only one number to a room even though the room may have two or more doors. (See sketches on pages 173 through 177.)

*Building Shape "A".* No preferences, except to conform with related buildings.

*Building Shape "B" and "D".* Odd numbers on the side of the principal entrance.

*Building Shapes "C" and "E".* Odd numbers on the "outside" modules of the building.

**Basic Modules** (Units of building space on which to base the pattern of room numbers.)

### *Determination of Modules*

- a. **In Direction of Progression.** By structural features which determine the closest practical spacing of partitions between rooms opening on the corridor. Generally, the determining structural feature is the location of windows and equivalent wall sections; each module should contain one, but usually not more than one, window or equivalent wall section.
- b. **Perpendicular to Direction of Progression.** Equivalent modules are on both sides of each corridor. Modules on both sides of a corridor are determined by the side requiring the greater number of modules.

### *Assignment of Module Numbers*

A single two-digit number (00 to 99) to each module with each even number being one greater than the opposite odd number. At a corner of a corridor, the module on the inside of the turn must sometimes be assigned two (or more) numbers, in which case the room number is determined by the location of the door.

### *General*

The one basic pattern of modules for all floors of a building is determined by the necessary patterns of the floor, or portions of different floors, which require the close spacing of modules.



# APPLICATION OF PATTERN

## Rooms of One Module

Room number is determined by module number. Note remark regarding module numbers for corner rooms in "Assignment of Module Numbers" above.

## Rooms of Two or More Modules

Room number is determined as follows:

- *One Entrance.* The number of the module containing the entrance.
- *Two or More Entrances.*
  - a. The number of the module containing the principal entrance; or
  - b. The number of the lowest-numbered module containing an entrance if the two or more entrances are of equal importance.

## Designation Floor

Sub-Basement.....	S-00 to S-99
Basement or Ground Floor .....	00 to 99
First Floor or Main Floor .....	100 to 199
Second Floor. ....	200 to 299
Third Floor, etc. ....	300 to 399

# SPECIAL CONSIDERATIONS

## Vertical Identity

Application of the principle generally ensures that corresponding room numbers (e.g., S-27, 27, 127, 227, 237, etc.) occupy the same relative position on all floors of the building.

## Large Building

*Four-Digit Room Numbers.* If the building is too large for satisfactory **two-digit module** numbers, **three-digit module** numbers should be used. In all other respects, the above-outlined principles are followed in assigning **four-digit room** numbers (e.g., 1000 to 1999 for the main or first floor and 2000 to 2999 for the second floor, etc.). Take the opportunity to use the first digit of the **module** number, i.e., the second digit of the **room** number, to designate sections (or wings) of the floor (e.g., 1100 to 1199 for east wing, 1200 to 1299 for west wing and 1300 to 1399 for south wing, etc.).

*Directional Signs.* At each entrance, at each stairway and elevator, and on the corridor wall at each corner of the building, there should be directional signs indicating the entire series of room numbers that can be more conveniently reached in each direction. Each sign should account for all room numbers on the floor.

## Form of Room Number

**All** room numbers should consist of a maximum of eight characters (8 positions - 2 alpha/numeric prefix, 4 numeric, a 2 alpha/numeric suffix). Normal room numbering entries will be in the central position.

## Numbers on Doors

The number appearing on, over or adjacent to each door is the number of the room to which the door provides access.

## Doors Other Than Those Into Rooms

For the sake of uniformity, every door along a corridor should bear a room number based on the module pattern, even those doors that merely provide access to utility service facilities and are not inventoried for state purposes.

## Interior Rooms

A room which has no corridor door, and which can be entered only through another room, is assigned the number of the corridor room plus a single alphabetic suffix (e.g., 0127A). Two or more interior rooms opening off the same corridor room are assigned consecutive alphabetic suffixes, generally beginning with "A" for the one whose door is nearest the corridor door. An interior room within an interior room is assigned the alphabetic suffix next in order after that of the interior room within which it is located.

## Spaces Other Than Rooms

Although the number generally will not appear on any door, each lobby, corridor, stairway, elevator and other space is assigned a "room" number in accordance with the module pattern. Ideally, every existing and potential space in the building is assigned a room number, even closets, unless, of course, doing so will complicate the existing room numbering system.

### **Additions to Existing Buildings**

As far as possible, room numbers in additions to existing buildings should continue the pattern of the original building.

### **Buildings to be Extended**

If larger extension of a building can reasonably be expected, the original assignment of room numbers should be made in accordance with an appropriately extensible pattern.

### Building Shape "A"

02 - 98 (even)							
02	04	06	08	10	12	14	16

00

01	03	05	07	09	11	13	15
01 - 99 (odd)							

Standard Pattern  
(Module Numbers)

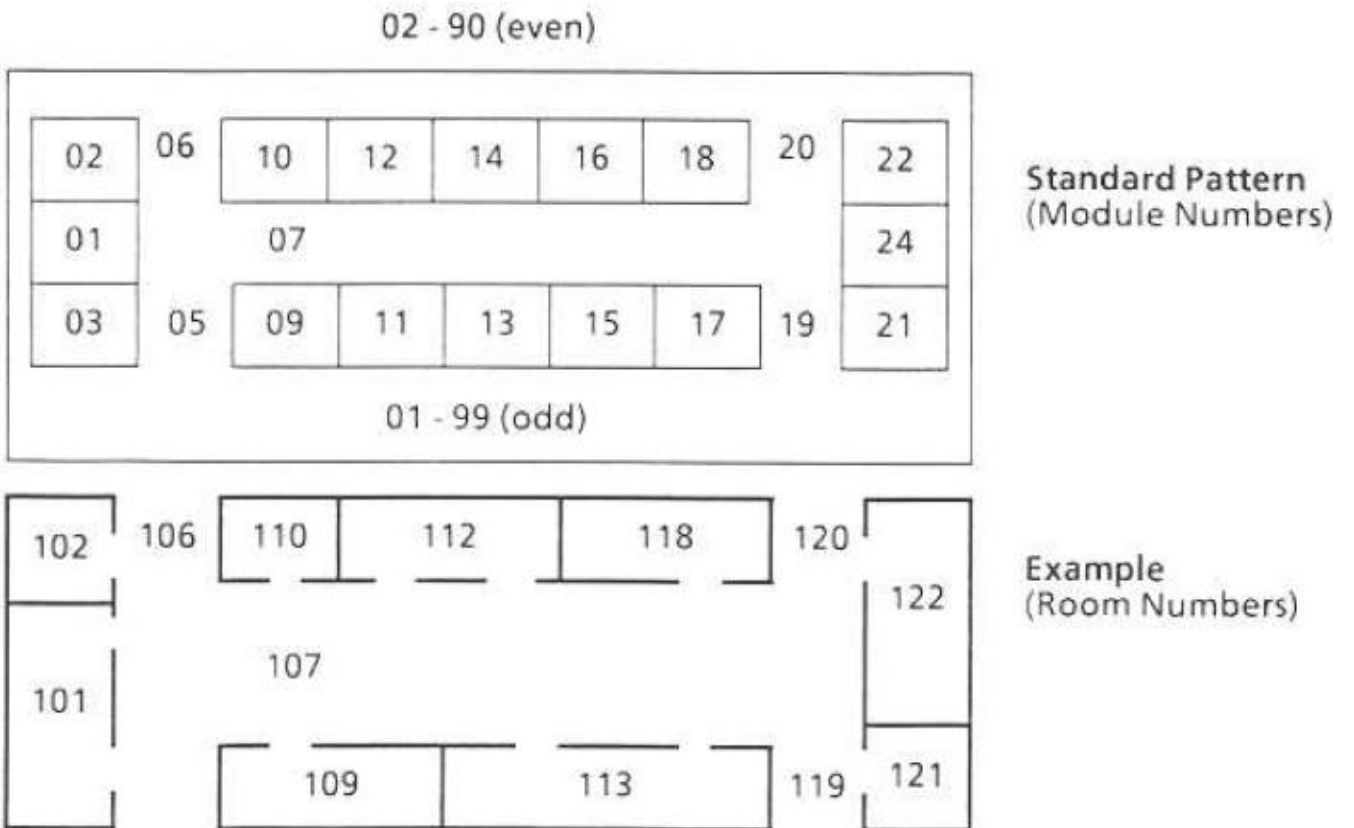
102	108	110	112	114
-----	-----	-----	-----	-----

100

Example  
(Room Numbers)

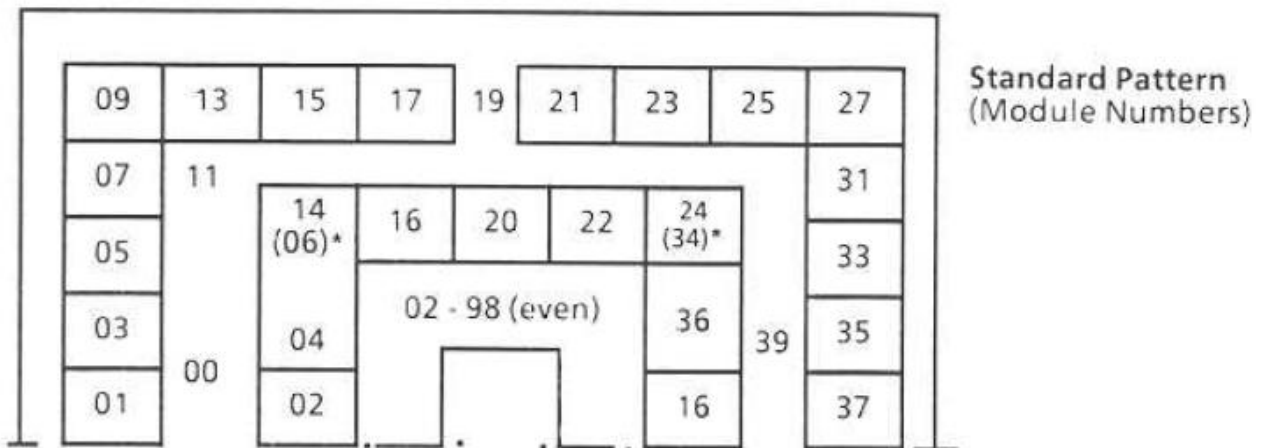
103	107	111	113	115
-----	-----	-----	-----	-----

### Building Shape "B"

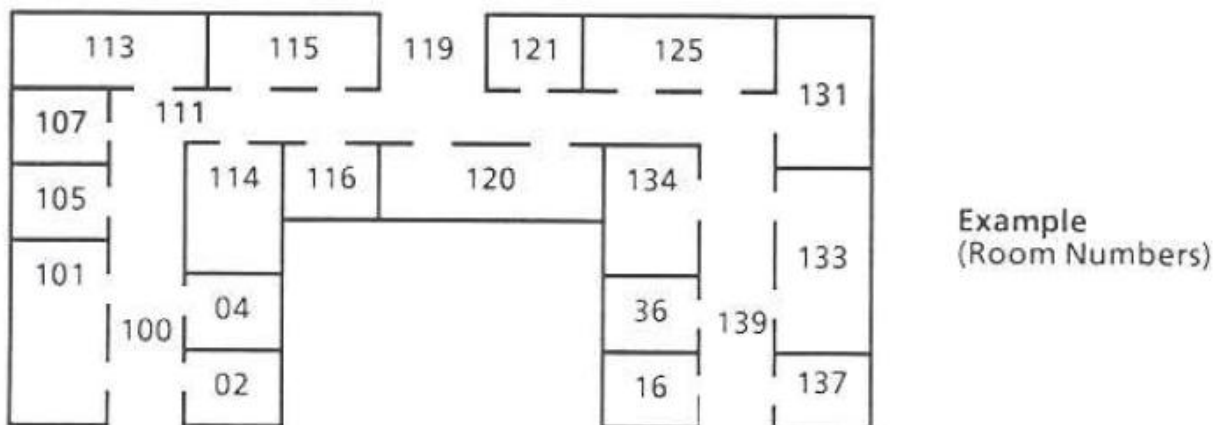


### Building Shape "C"

01 - 99 (odd)

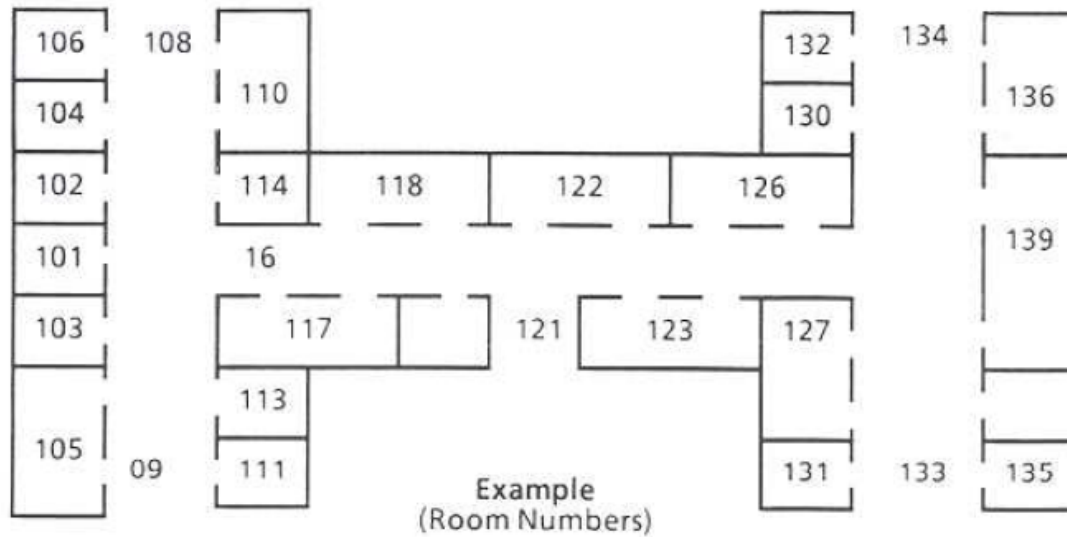
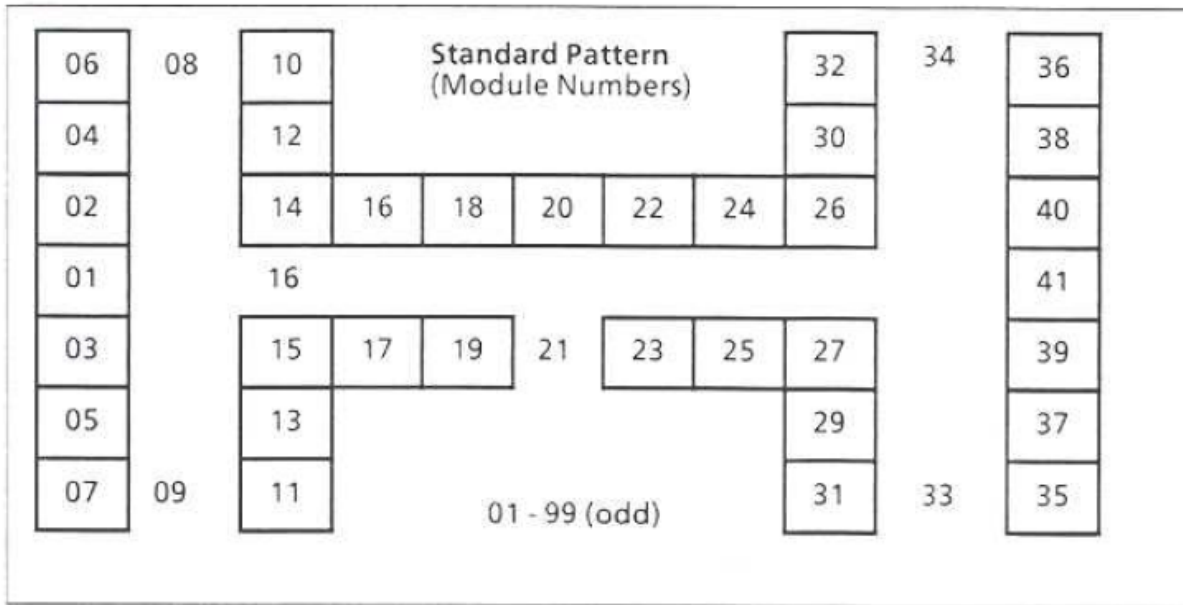


\*Depending on door location



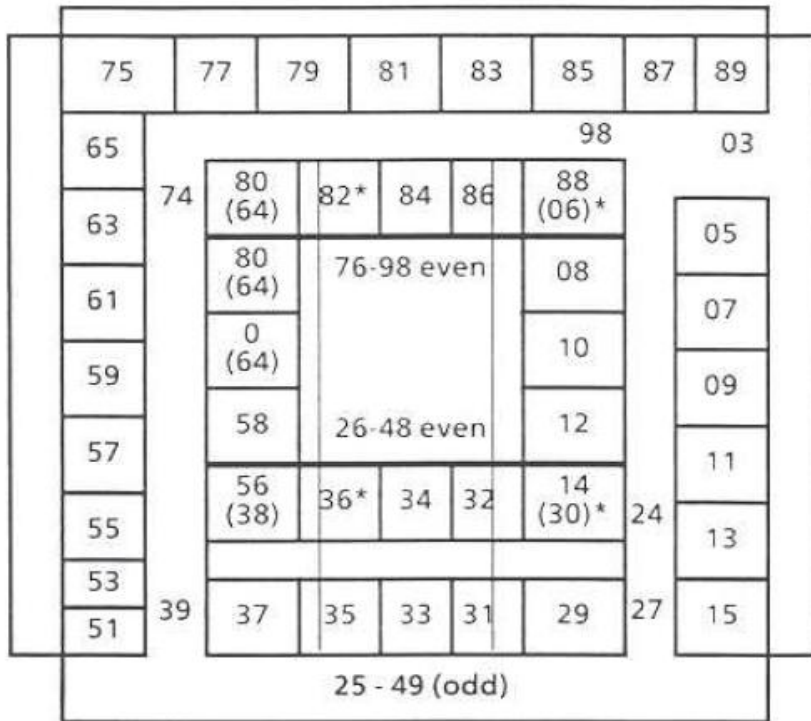
### Building Shape "D"

02 - 98 (even)



### Building Shape "E"

75 - 89 (odd)



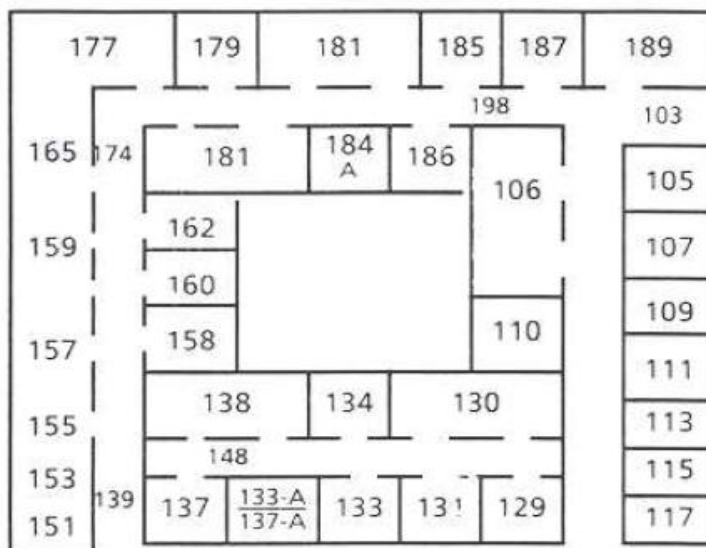
**Standard Pattern  
(Module Numbers)**

2-Digit\*\*  
01 - 24  
25 - 49  
50 - 74  
etc.

3-Digit  
001 - 249  
250 - 499  
500 - 740  
etc.

\*\* As shown at left

\* Depending on door location



**Example  
(Room Numbers)**

3-Digit\*\*  
101 - 123  
125 - 149  
150 - 174  
etc.

4-Digit  
1101 - 1249  
1250 - 1499  
1500 - 1749  
etc.

\*\* As shown at left